

Panasonic

Personal Facsimile

Model No.

KX-FT31BX

Quick Start



To get started,
please read the
Quick Start section.

Initial Preparation

Telephone

Fax/Copy

Help

General Information

OPERATING INSTRUCTIONS

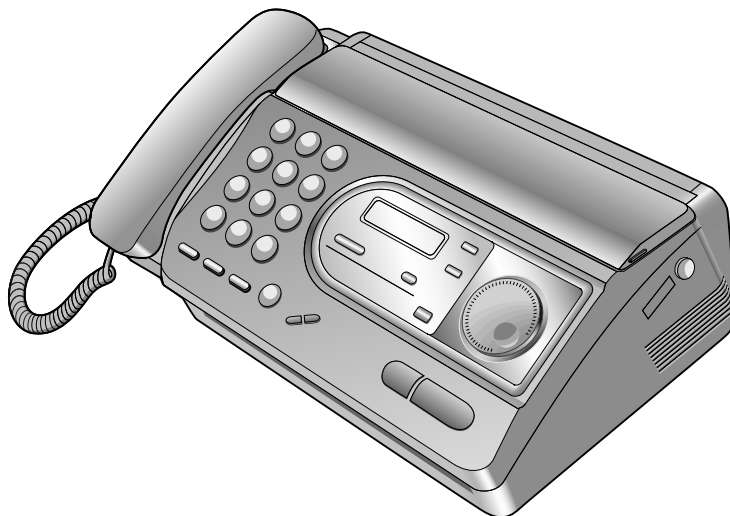

Please read these Operating Instructions
before using the unit and save for future
reference.

Thank you for purchasing a Panasonic Facsimile.

Welcome to the world of Panasonic facsimiles.

This product combines the facsimile, telephone and copier features, to provide you with more efficient office or home use. By utilizing these convenient features, you can maximize the effectiveness of this unit.

For your future reference

Date of purchase _____

Serial number _____

(found on the back of the unit)

Dealer's name and address _____

Dealer's telephone number _____

Copyright:

This manual is copyrighted by Kyushu Matsushita Electric Co., Ltd. (KME) and its licensee. Under the copyright laws, this manual may not be reproduced in any form, in whole or part, without the prior written consent of KME and its licensee.

© Kyushu Matsushita Electric Co., Ltd. 1997

Important safety instructions

When using this unit, basic safety precautions should always be followed to reduce the risk of fire, electric shock, or personal injury.

1. Read and understand all instructions.
2. Follow all warnings and instructions marked on this unit.
3. Unplug this unit from AC outlets before cleaning. Do not use liquid or aerosol cleaners. Use a damp cloth for cleaning.
4. Do not use this unit near water, for example, near a bath tub, wash bowl, kitchen sink, or the like.
5. Place the unit securely on a stable surface. Serious damage and/or injury may result if the unit falls.
6. Do not cover slots and openings on the unit. They are provided for ventilation and protection against overheating. Never place the unit near radiators, or in a place where proper ventilation is not provided.
7. Use only the power source marked on the unit. If you are not sure of the type of power supplied to your home, consult your dealer or local power company.
8. For safety purposes this product is equipped with a three prong grounded plug. If you do not have this type of outlet, please have one installed. Do not use any type of adaptor plug to defeat this safety feature.
9. Do not place objects on the power cord. Install the unit where no one can step or trip on the cord.
10. Do not overload wall outlets and extension cords. This can result in the risk of fire or electric shock.
11. Never push any objects through slots in this unit. This may result in the risk of fire or electric shock. Never spill any liquid on the unit.
12. To reduce the risk of electric shock, do not disassemble this unit. Take the unit to an authorized servicer when service is required. Opening or removing covers may expose you to dangerous voltages or other risks. Incorrect reassembly can cause electric shock when the unit is subsequently used.
13. Unplug this unit from the wall outlet and refer servicing to an authorized servicer when the following conditions occur:
 - A. When the power supply cord or plug is damaged or frayed.

- B. If liquid has been spilled into the unit.
 - C. If the unit has been exposed to rain or water.
 - D. If the unit does not work normally by following the operating instructions. Adjust only controls covered by the operating instructions. Improper adjustment may require extensive work by an authorized servicer.
 - E. If the unit has been dropped or physically damaged.
 - F. If the unit exhibits a distinct change in performance.
14. During thunderstorms, avoid using telephones except cordless types. There may be a remote risk of an electric shock from lightning.
 15. Do not use this unit to report a gas leak, when in the vicinity of the leak.

SAVE THESE INSTRUCTIONS

INSTALLATION:

1. Never install telephone wiring during a lightning storm.
2. Never install telephone jacks in wet locations unless the jack is specifically designed for wet locations.
3. Never touch uninsulated telephone wires or terminals unless the telephone line has been disconnected at the network interface.
4. Use caution when installing or modifying telephone lines.



WARNING:

- To prevent the risk of fire or electrical shock, do not expose this product to rain or any type of moisture.

OTHER INFORMATION:

- Keep the unit away from electrical noise-generating devices, such as fluorescent lamps and motors.
- The unit should be kept free from dust, high temperature, and vibration.
- The unit should not be exposed to direct sunlight.
- Do not place heavy objects on top of this unit.
- Do not touch the plug with wet hands.

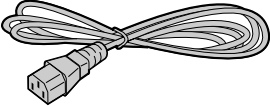
Included accessories

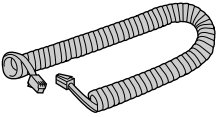
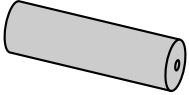
<p>Power cord 1 pc.</p> 	<p>Telephone line cord 1 pc.</p> 	<p>Handset 1 pc.</p> 
<p>Handset cord 1 pc.</p> 	<p>Recording paper 1 pc.</p>  <p>— See the next page for replacing the recording paper.</p>	

- If any items are missing or damaged, check with the place of purchase.
- Save the original carton and packing materials for future shipping and transporting of the unit.

Accessory order information

Use the following types of recording paper for replacement.

Model No.	Description	Specifications
KX-A106	Standard thermal recording paper	216 mm x 30 m (8 1/2" x 98') roll, with 25 mm (1") core
KX-A125	Super thermal recording paper (Like plain paper)	216 mm x 30 m (8 1/2" x 98') roll, with 25 mm (1") core

Help function

You can print a quick reference for assistance as follows.

1 Select which operation you want to print out by pressing **HELP** repeatedly.

- Pressing **HELP** one time

1.HOW TO SET UP

two times

2.EASY DIAL

three times

3.FAX OPERATION

four times

4.RECEIVE MODE

2 Press **START/COPY/SET**.

PRINTING

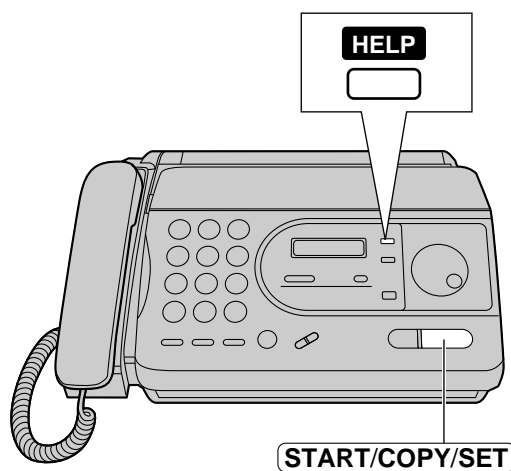

Note:

- When you press **HELP** during programming, the unit will print out a quick reference for that feature.

Table of Contents

Quick Start

To install the recording paper	8
To connect the unit	9
To make a voice call	10
To answer a voice call	10
To send faxes	11
To receive faxes	12
To make a copy	13

Initial Preparation

Finding the Controls	Location	14
	Overview	16
Setup	Installing the recording paper	17
	Connections	18
	Programming the date and time, your name and facsimile telephone number	19
Volumes	Adjusting volumes	23

Telephone

Making and Answering Calls	Making a voice call manually	24
	Answering a voice call	24
	TONE, FLASH and PAUSE buttons	25
EASY DIAL	Storing names and telephone numbers in the EASY DIAL directory	26
	Making a voice call using the EASY DIAL directory	29
Voice Contact	Talking to the caller after fax transmission or reception	30

Fax/Copy

Sending Faxes	Sending faxes manually	31
	Sending faxes using the EASY DIAL directory	32
	Documents you can send	33
	Printing the transmission report	34
	Setting the journal report to print automatically	35
	Delayed transmission (sending a fax at a specific time)	36
	Sending documents overseas	37
	Transmit polling (letting another machine retrieve a fax on your unit)	37

(continued)

Fax/Copy	Receiving Faxes	Selecting the way to receive calls	38
		TEL mode (answering all calls manually)	40
		FAX ONLY mode (all calls are received as faxes)	41
		TEL/FAX mode (receiving voice calls with rings and fax calls without rings)	42
		EXT.TAM mode (using with an external telephone answering machine)	45
		Distinctive ring service (ring pattern detection feature)	48
		Receiving faxes using an extension telephone	50
		Changing the fax activation code	51
		Receive polling (retrieving faxes placed on another party's machine)	52
		Setting the silent detection (receiving faxes from older model facsimiles)	53
	Setting the friendly reception	54	
	Signaling your pager when your unit receives a fax	55	
	Copying	Making a copy	56
Help	Error Messages	Error messages on printed reports	57
		Error messages on the LCD display	58
	Operations	When a function does not work, check here before requesting help	59
		If a power failure occurs	61
	Jams	Clearing a recording paper jam	62
		When a document you are sending jams	63
		When documents you send do not feed, or multi-feed	63
	Cleaning	Cleaning the document feeder	64
		Cleaning the thermal head	64
	General Information	Print Reports	Printing the feature settings, telephone numbers, and the journal
Display Contrast		Changing the LCD display contrast	66
Reset		Resetting the advanced features	67
Features Summary		Summary of user programmable features	68
Specifications		Technical data about this product	70
Index		Index	71

Initial Preparation

Telephone

Fax/Copy

Help

General Information

Quick Start

To install the recording paper

1 Open the cover by pressing the cover open button.

2 Install a recording paper roll.

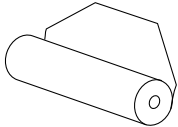

correct

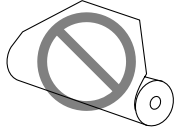

incorrect

3 Pull the leading edge of the paper out of the unit.

4 Close the cover securely, and tear off the excess paper.

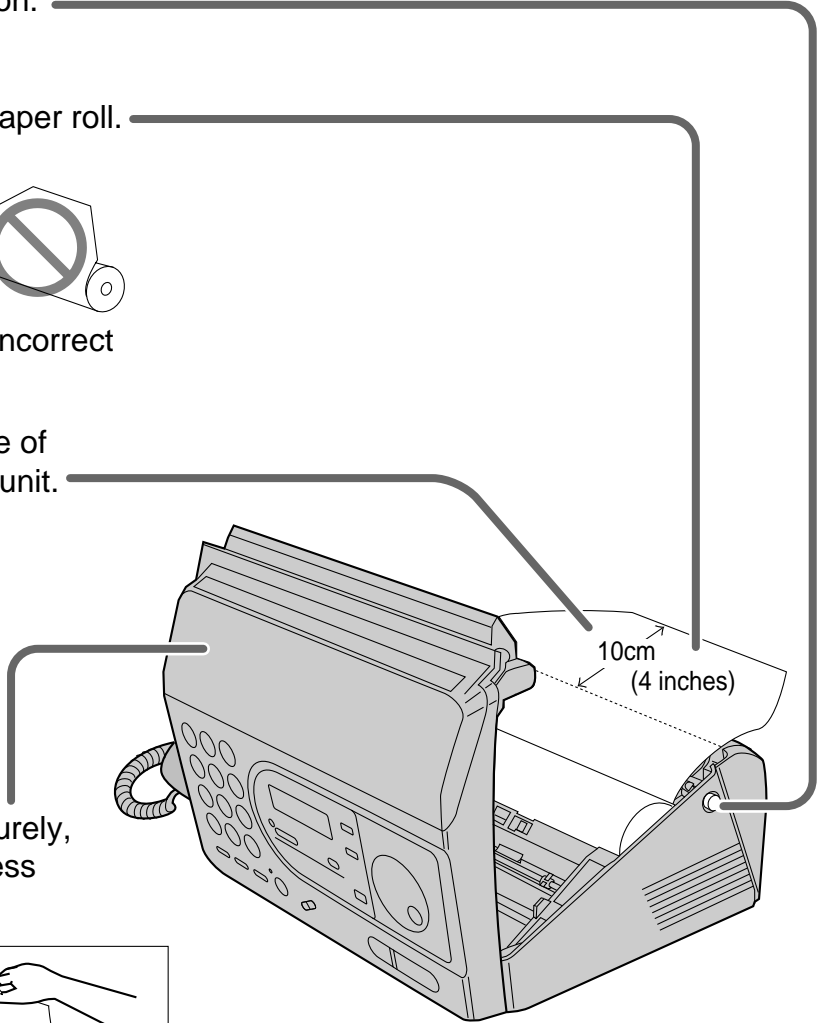
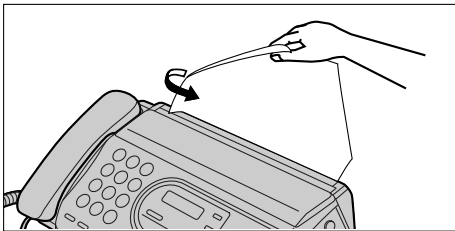

● For further details, see page 17.

To connect the unit

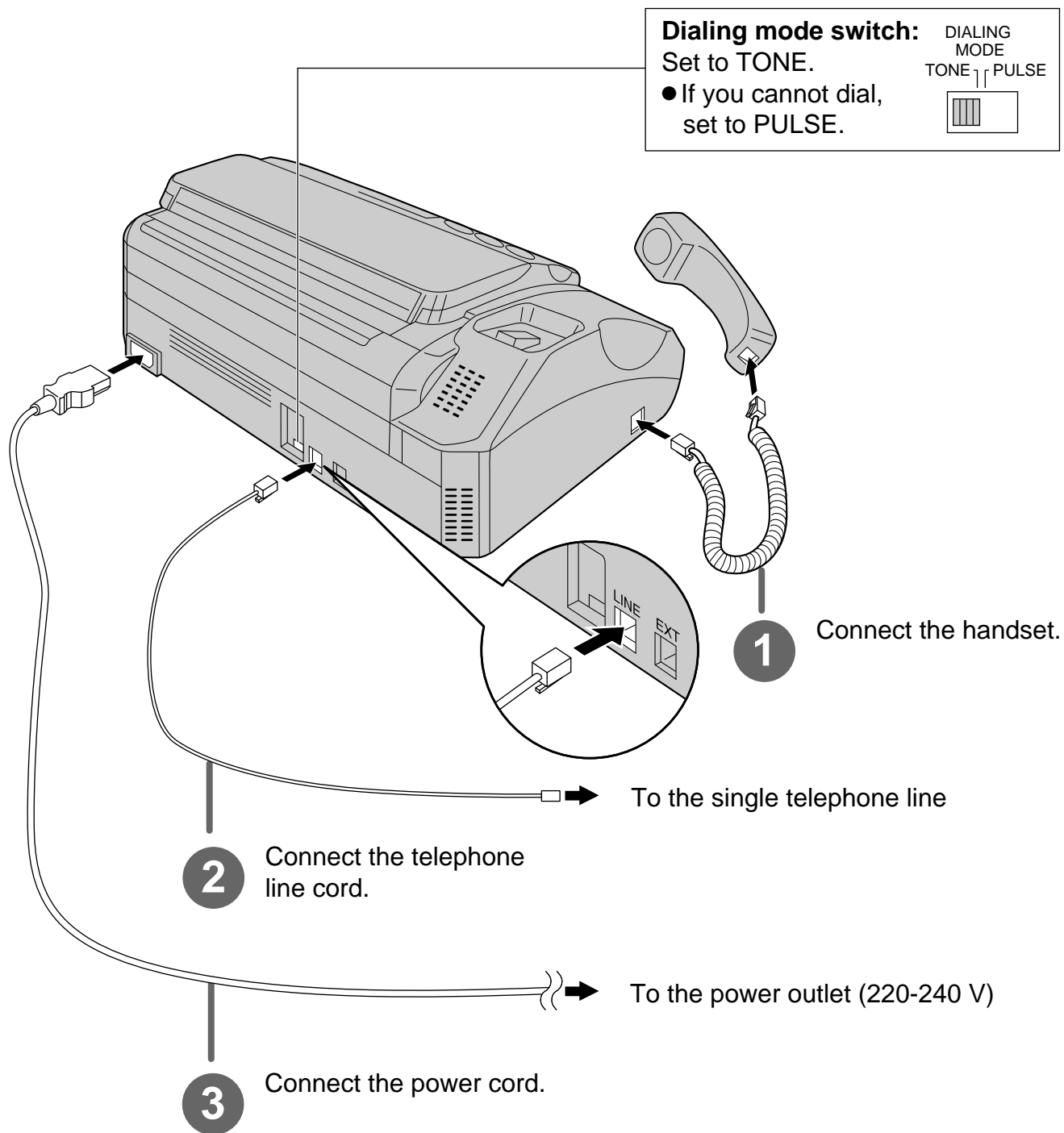

- For further details, see page 18.
- You can print a quick reference for assistance (see the “Help function” on page 5).

Quick Start

To make a voice call

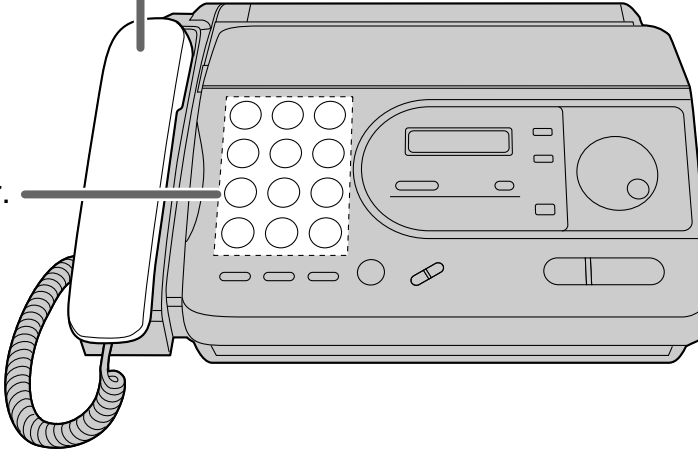
- 1** Lift the handset.
 - 2** Dial the number.
 - 3** When finished, hang up the handset.
- 
- A line drawing of a corded telephone. The handset is on the left, connected to the base unit on the right. The base unit features a numeric keypad, a display screen, and several control buttons. A dashed rectangular box highlights the numeric keypad. A line from the number '1' in the first step points to the handset. A line from the number '2' in the second step points to the numeric keypad. A line from the number '3' in the third step points to the handset.

To answer a voice call

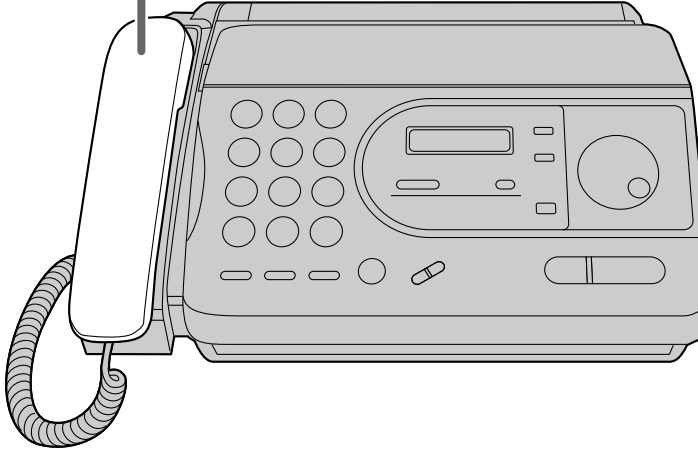
- 1** When the unit rings, lift the handset.
 - 2** When finished, hang up the handset.
- 
- A line drawing of a corded telephone, identical to the one in the first section. A line from the number '1' in the first step points to the handset. A line from the number '2' in the second step points to the handset.

● For further details, see page 24.

To send faxes

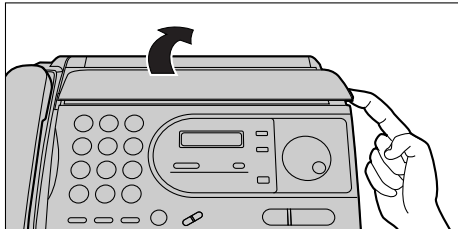
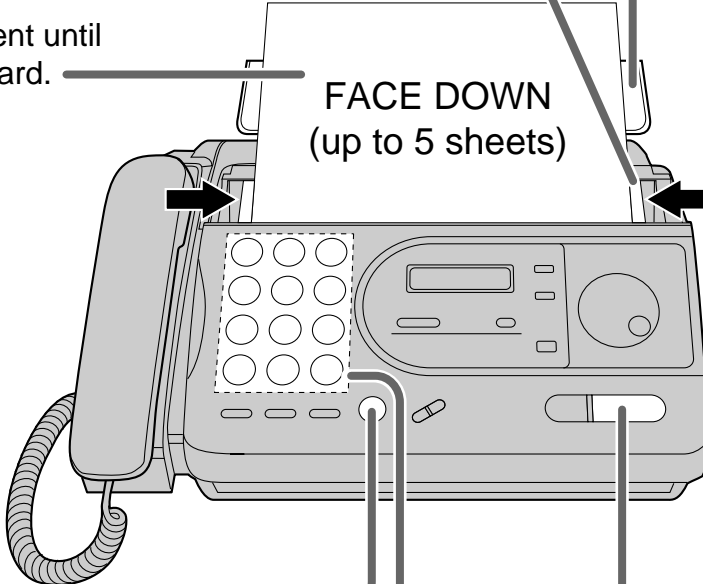
- 1** Open the document feeder tray.

- 2** Adjust the width of the document guides to the size of the document.
- 3** Insert the document until a beep tone is heard.

- 4** Press **MONITOR**.
- 5** Dial the fax number.
- 6** When a fax tone is heard, press **START/COPY/SET**.

● For further details, see page 31.

Quick Start

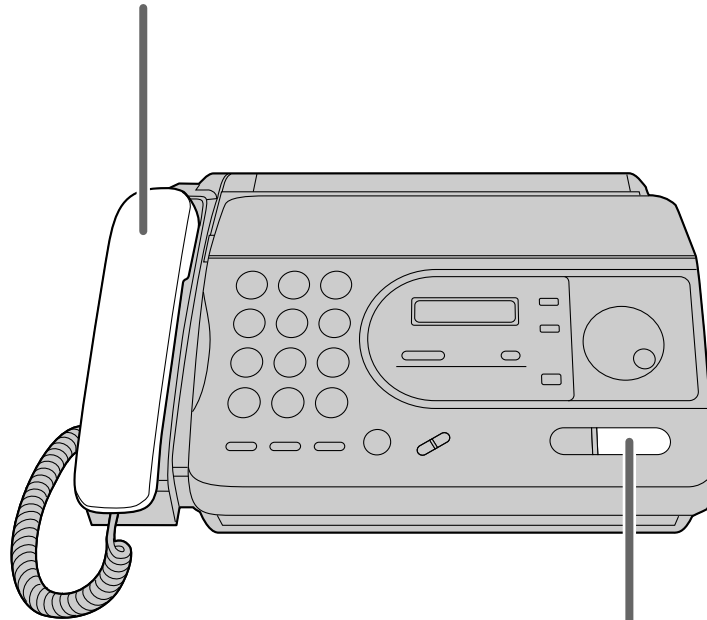
To receive faxes

1 When the unit rings, lift the handset.



2 When:
—document reception is required,
—a fax calling tone (slow beep) is heard, or
—no sound is heard,
press **START/COPY/SET** .

3 Hang up the handset.

- For further details, see page 40.
- You can select the desired receive mode according to your needs. See pages 38 and 39.

To make a copy

- 1 Open the document feeder tray.

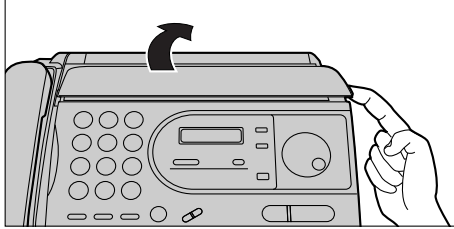

- 2 Adjust the width of the document guides to the size of the document.

- 3 Insert the document until a beep tone is heard.

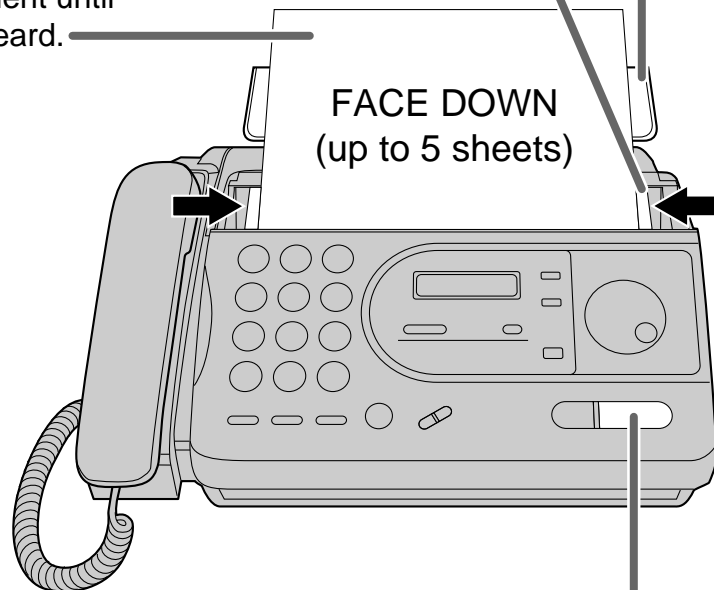

- 4 Press **START/COPY/SET**.

● For further details, see page 56.

Location

- Used to change from pulse to tone during dialing (p. 25).
 - Used to turn on/off the auto receive mode (p. 38, 39).
 - Used as an insert key (p. 21, 27).
 - Used to select a resolution (p. 31).
 - Used as a hookswitch (p. 25).
 - Used for handset muting (p. 24).
 - Used as a hyphen key (p. 27).
 - Used to redial the last number dialed (p. 24, 31).
 - Used to insert a pause during dialing (p. 25).
 - Used to dial without lifting the handset.
 - Used to adjust volumes (p. 23).
 - Used to select feature settings during programming.
-
- The diagram shows a telephone control panel with the following components and labels:
- Dial keypad:** A 12-button keypad with numbers 1-9, 0, *, and #. Each number key has its corresponding letters above it: 1 (no letters), 2 (ABC), 3 (DEF), 4 (GHI), 5 (JKL), 6 (MNO), 7 (PQRS), 8 (TUV), 9 (WXYZ), 0 (no letters), * (TONE), # (no letters).
 - Display panel:** A rectangular area containing an **AUTO RECEIVE** switch with a radio button and the label **FAX**, and a **RESOLUTION** switch.
 - MONITOR:** A circular button.
 - VOLUME:** A slider control with four directional arrows (up, down, left, right) and labels **RINGER**, **HANDSET**, and **MONITOR**.
 - FLASH:** A rectangular button.
 - REDIAL /PAUSE:** A rectangular button.
 - HANDSET MUTE:** A rectangular button.

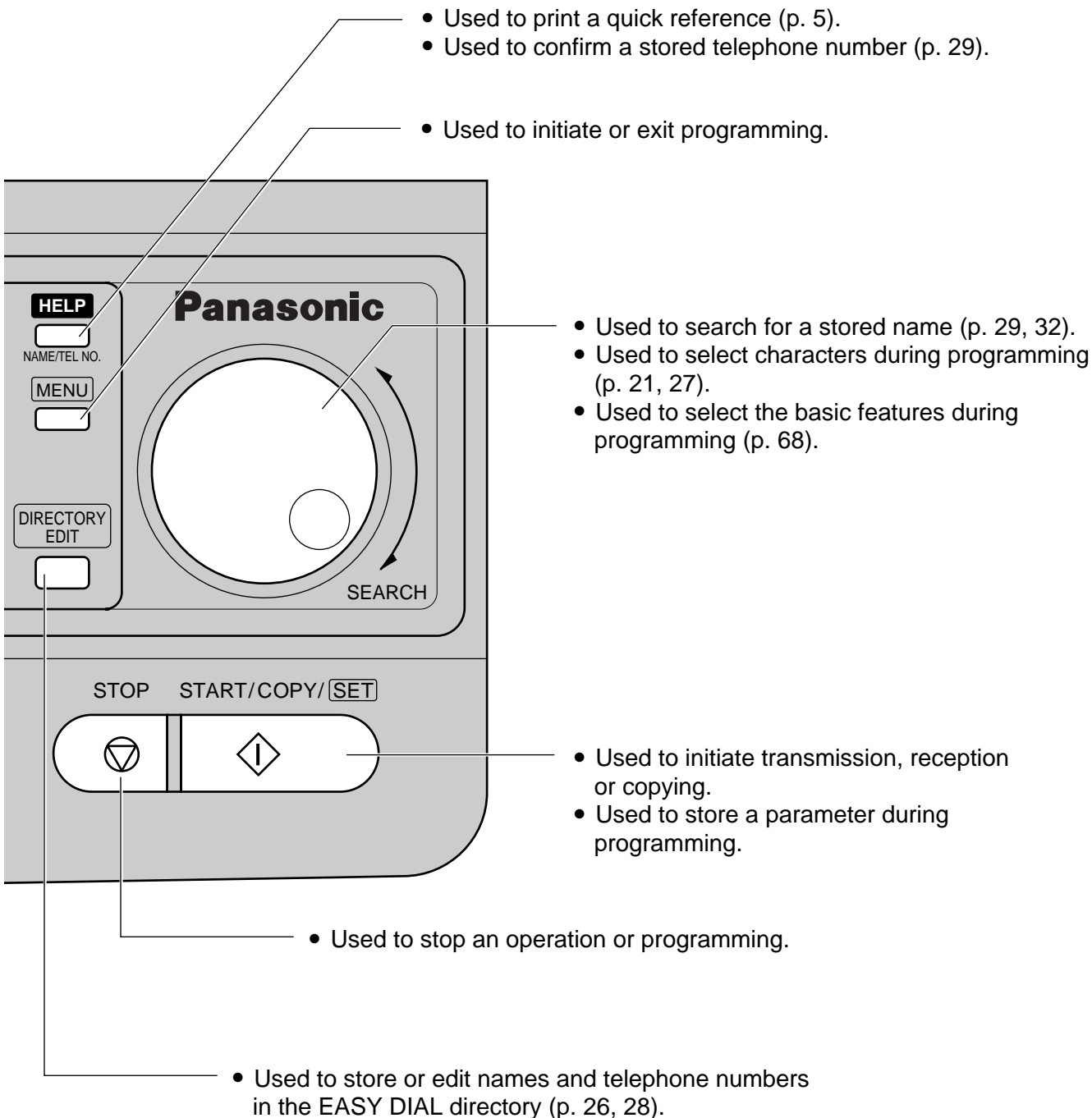

Overview

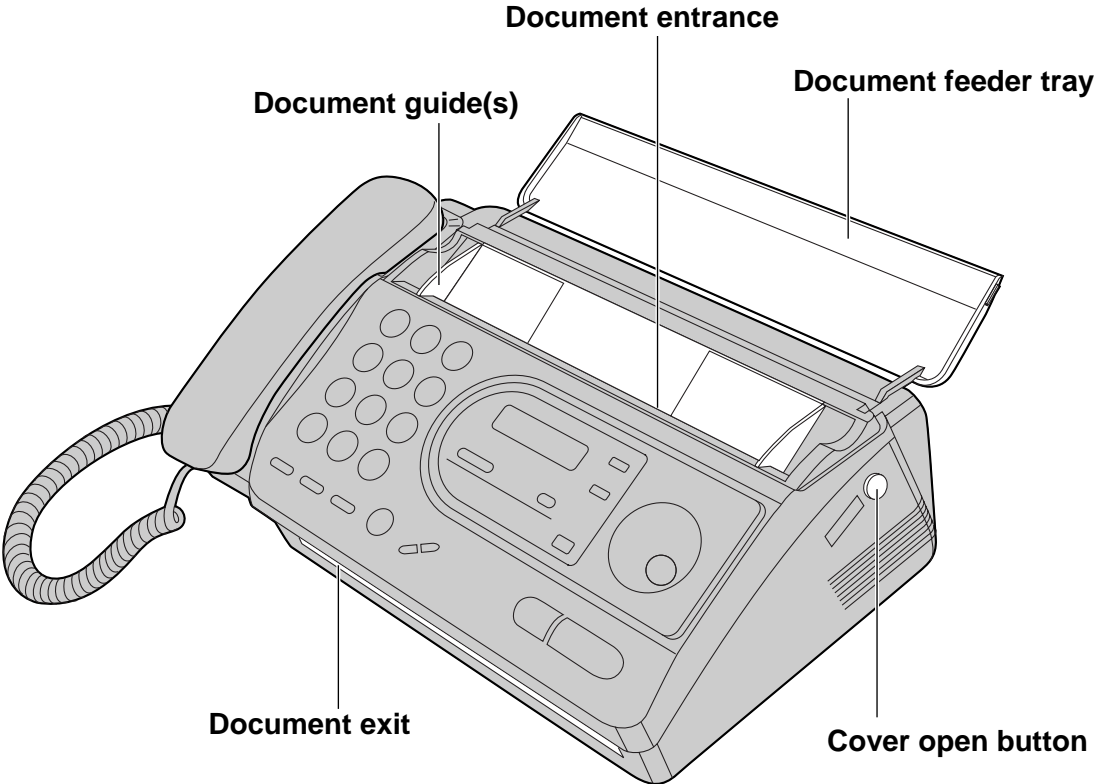

Installing the recording paper

- 1** Open the cover by pressing the cover open button and install the recording paper roll.
- If the paper is secured with glue or tape, cut approximately 15 cm (6 inches) from the beginning.

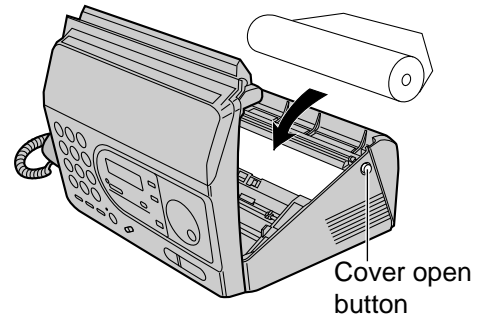

- 2** Pull the leading edge of the paper approximately 10 cm (4 inches) out of the unit.
- Make sure that the shiny side of the paper is facing down and there is no slack.

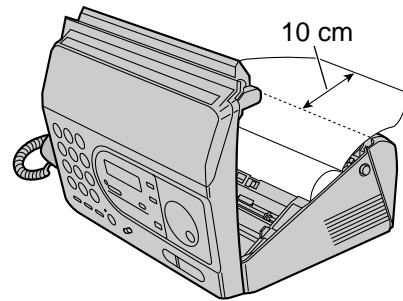
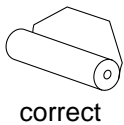

- 3** Close the cover securely by pushing down on both corners.
- When you close the cover, do not push the flaps down or a paper jam will occur.

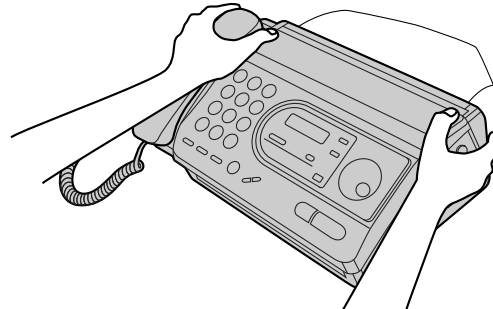
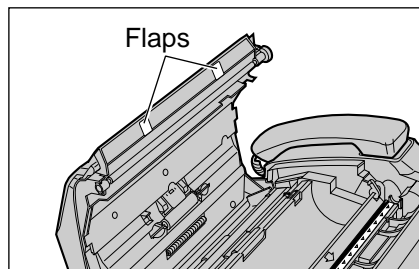

- 4** Tear off the excess paper by pulling it towards you.

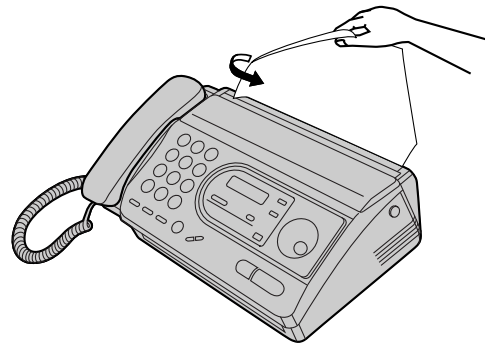

Note:

- Only use the included roll of paper or specified recording paper, or else the print quality may be affected and/or excessive thermal head wear may occur.
- To order recording paper, see page 5.
- When the power cord is connected, everytime you close the cover a message will be printed. If the recording paper is set to the wrong side, a message will not be printed. Install the paper correctly.

Connections

- 1 Connect the handset cord.
- 2 Connect the telephone line cord.
- 3 Connect the power cord.

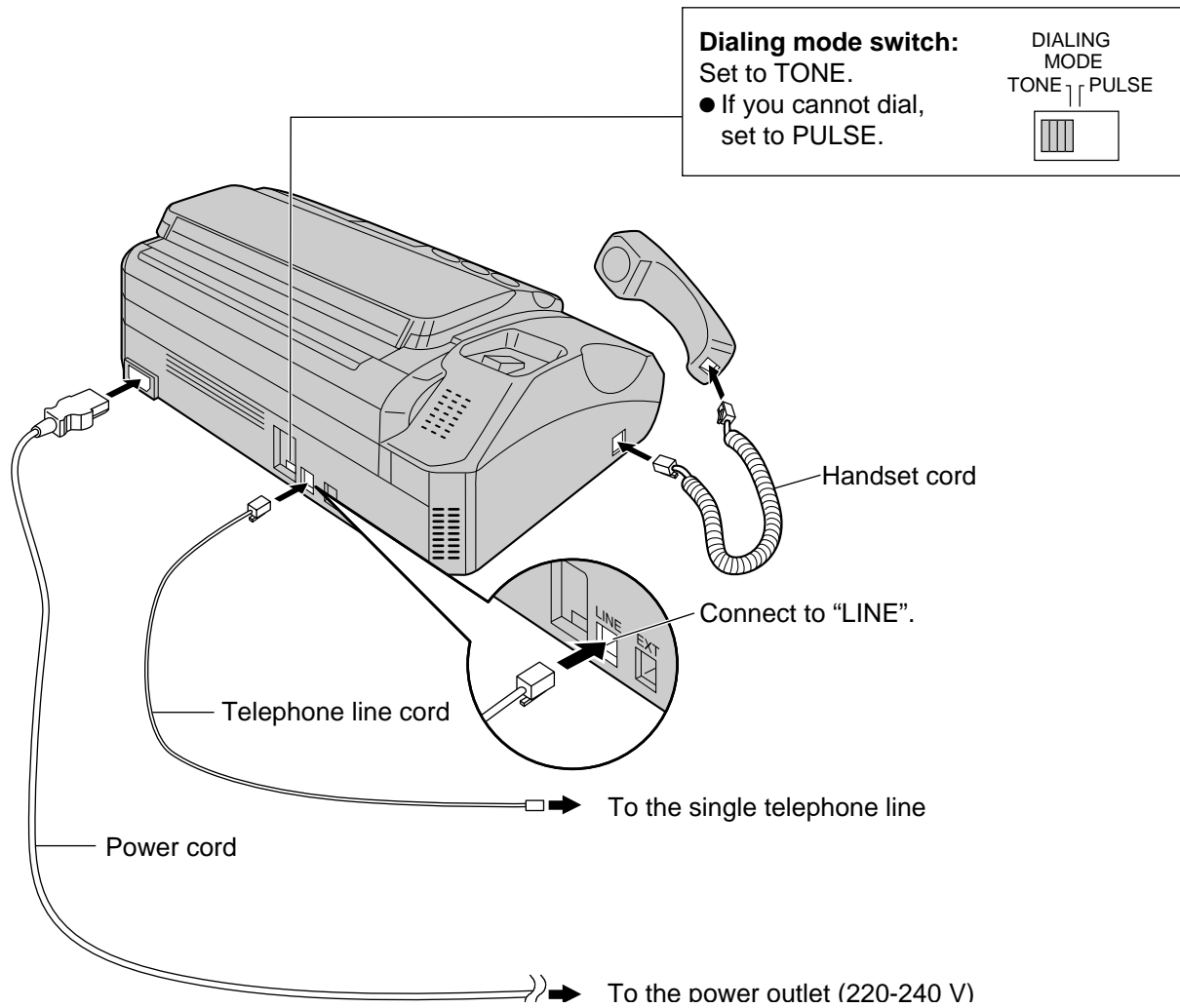

Note:

- When you operate this product, the power outlet should be near the product and easily accessible.

Programming the date and time, your name and facsimile telephone number

You can program the date and time, your logo and facsimile telephone number and this information will be printed on each page transmitted from your unit.

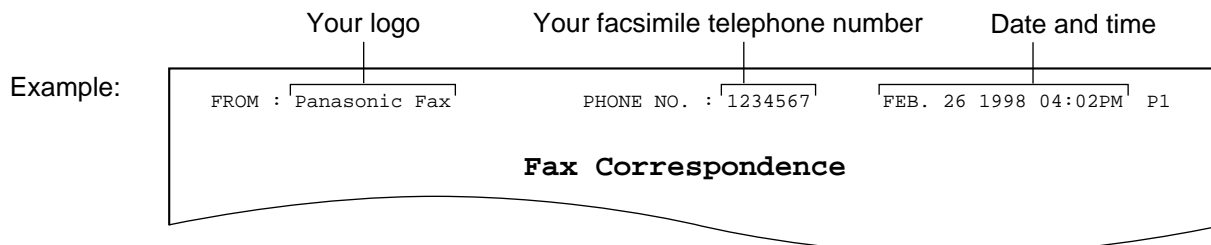

Setting the date and time

1 Press **MENU**.
Display: 1.SYSTEM SET UP

2 Press **⏏**, then **0 1**.
SET DATE & TIME

3 Press **START/COPY/SET**.
M:01/D:01/Y:98
Cursor

4 Enter the correct month/day/year by selecting each 2 digits.

Example: Aug. 10, 1998

Press **0 8 1 0 9 8**.

M:08/D:10/Y:98

5 Press **START/COPY/SET**.
TIME: 12:00AM

6 Enter the correct hour/minute by selecting each 2 digits. Press ***** to select AM or PM.

Example: 3:15PM

1. Press **0 3 1 5**.

TIME: 03:15AM

2. Press ***** until PM is displayed.

TIME: 03:15PM

7 Press **START/COPY/SET**.
SETUP ITEM []

8 Press **MENU**.

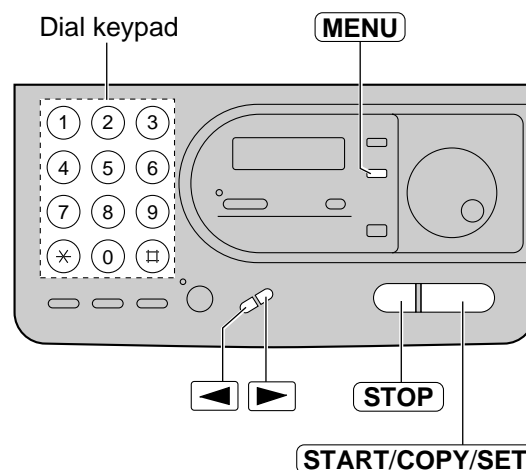

Note:

- The ***** key can be used to select AM or PM wherever the cursor is located.
- The accuracy of the clock will be approximately ± 60 seconds a month.

To correct a mistake

- Press **◀** or **▶** to move the cursor to the incorrect number, then make the correction.
- If you press **STOP** while programming, the display will return to the previous one.

Setting your logo

The logo can be your company, division or personal name.

1 Press **MENU**.
 Display: 1.SYSTEM SET UP

2 Press **⏏**, then **0 2**.
 YOUR LOGO

3 Press **START/COPY/SET**.
 LOGO=

4 Enter your logo, up to 30 characters, by following the instructions on the next page.

Example (using the dial keypad): Bill

1. Press **2** twice. LOGO=B
 Cursor

2. Press **4** six times. LOGO=Bi

3. Press **5** six times. LOGO=Bill

4. Press **▶** to move the cursor to the next space and press **5** six times.

LOGO=Bill

5 Press **START/COPY/SET**.
 SETUP ITEM []

6 Press **MENU**.

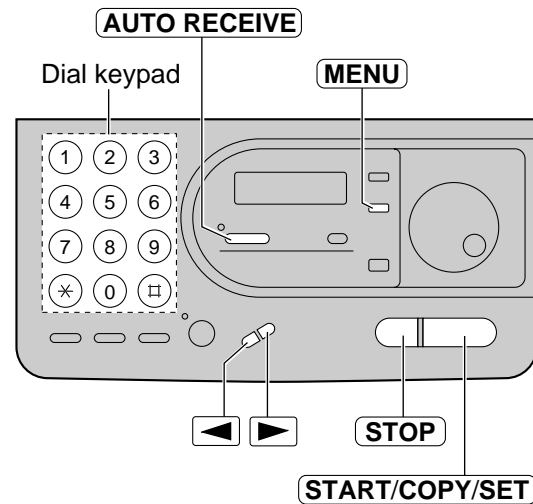

To correct a mistake

- Press **◀** or **▶** to move the cursor to the incorrect character, then make the correction.

To delete a character

- Move the cursor to the character you want to delete and press **STOP**.

To insert a character

1. Press **◀** or **▶** to move the cursor to the position to the right of where you want to insert the character.
2. Press **AUTO RECEIVE** to insert a space and enter the character.

Selecting characters with the dial keypad

Pressing the dial keys will select a character as shown below.

Keys	Characters
①	1 [] { } + - / = , . _ ' : ; ?
②	A B C a b c 2
③	D E F d e f 3
④	G H I g h i 4
⑤	J K L j k l 5
⑥	M N O m n o 6
⑦	P Q R S p q r s 7
⑧	T U V t u v 8
⑨	W X Y Z w x y z 9
⑩	0 () < > ! " # \$ % & ¥ * @ ^ ' ¨
AUTO RECEIVE	Insert key (Used to insert a space.)
VOLUME ▼	◀ key (Used to move the cursor to the left.)
VOLUME ▲	▶ key (Used to move the cursor to the right.) To enter the same number key continuously, move the cursor to the next space.

Selecting characters with the EASY DIAL

Instead of pressing the dial keys, you can select characters using the EASY DIAL.

1. Rotate **EASY DIAL** until the desired character is displayed.
2. Press ▶ to move the cursor to the next space.
 - The character displayed in step 1 is inserted.
3. Return to step 1 to enter the next character.

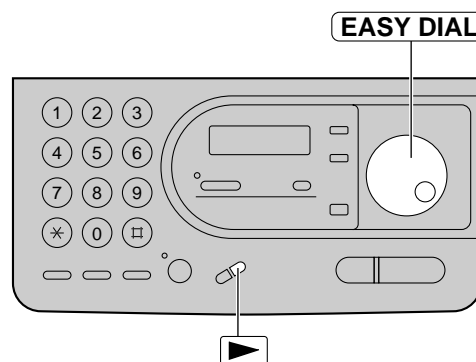

Display order of characters

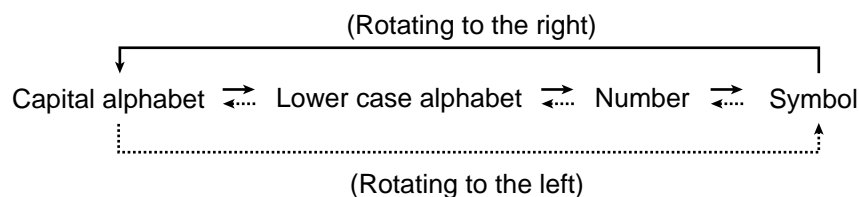

Setting your facsimile telephone number

- 1 Press **MENU**.
Display: 1.SYSTEM SET UP
- 2 Press **▣**, then **0 3**.
YOUR TEL NO.
- 3 Press **START/COPY/SET**.
NO. =
- 4 Enter your facsimile telephone number up to 20 digits.
Example: NO.=1234567
- 5 Press **START/COPY/SET**.
SETUP ITEM []
- 6 Press **MENU**.

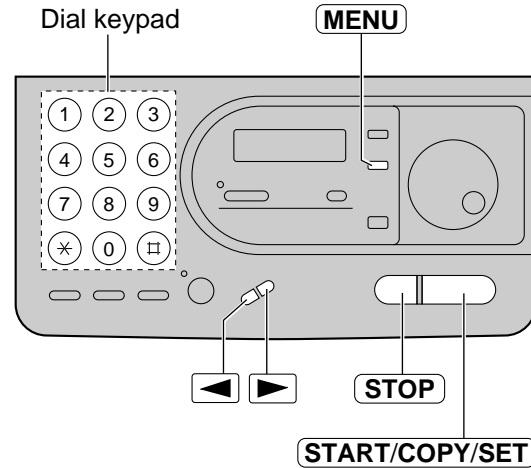

Note:

- The **▣** button inserts a space and the ***** button a “+”.

Example: +234 5678

Press *** 2 3 4 ▣ 5 6 7 8**.

To correct a mistake



- Press **◀** or **▶** to move the cursor to the incorrect number, then make the correction.

To delete a number

- Move the cursor to the number you want to delete and press **STOP**.

Adjusting volumes

Ringer volume

4 levels (high/middle/low/off) are available.
Press  or  while the unit is idle.

■ To turn the ringer off:

1. Press  repeatedly until the following message is displayed.

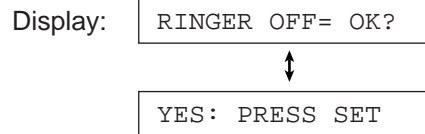

2. Press START/COPY/SET.

- To turn the ringer back on, press .

n While the ringer volume is set to off:



The display will show the following message.



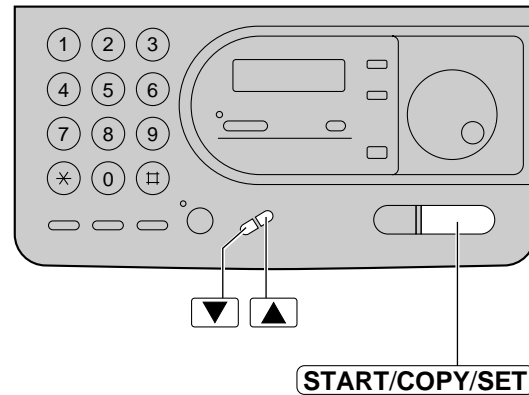

When receiving a call, the unit will not ring but will display the following.



Handset receiver volume

5 levels (high to low) are available.
Press  or  while using the handset.

Monitor speaker volume

8 levels (high to low) are available.
Press  or  while using the monitor.

Making a voice call manually

- 1 Press **MONITOR** or lift the handset.
Display:
- 2 Dial the telephone number.
Example:
 - If you misdial, hang up and dial again.
- 3 When the other party answers, talk using the handset.
- 4 When finished, hang up the handset.

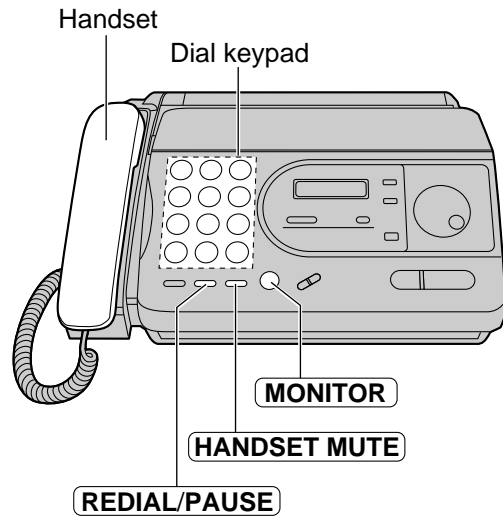

To redial the last number

1. Press **MONITOR** or lift the handset.
2. Press **REDIAL/PAUSE**.
 - If the line is busy when using the **MONITOR** button, the unit will automatically redial the number up to 14 times.
 - While waiting for redial, the following will be displayed.

Answering a voice call

- 1 When the unit rings, lift the handset.
- 2 When finished, hang up the handset.

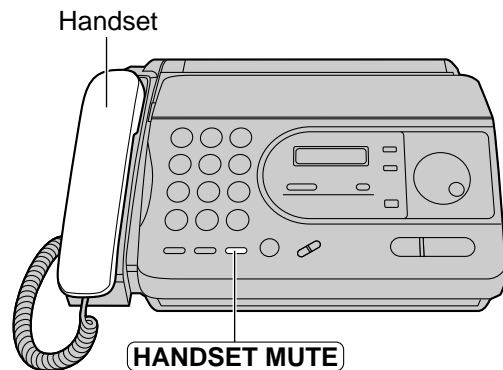

Muting your voice to the other party

1. Press **HANDSET MUTE** during a telephone conversation with the handset.
Display:
 - The other party cannot hear you, but you can hear them.
2. To resume the conversation, press **HANDSET MUTE**.

TONE, FLASH and PAUSE buttons

TONE button

The **TONE** (*) button is used for rotary pulse dial services and allows you to temporarily change from the pulse to tone mode during a dialing operation. When you hang up, the unit will automatically return to the pulse mode.

FLASH button

The **FLASH** button functions as the hookswitch on a regular telephone. If you misdial a telephone number, press the **FLASH** button firmly.

The **FLASH** button also allows you to use special features of a host exchange (if connected) or local telephone company services such as call waiting. For further details, contact your host exchange supplier or local telephone company.

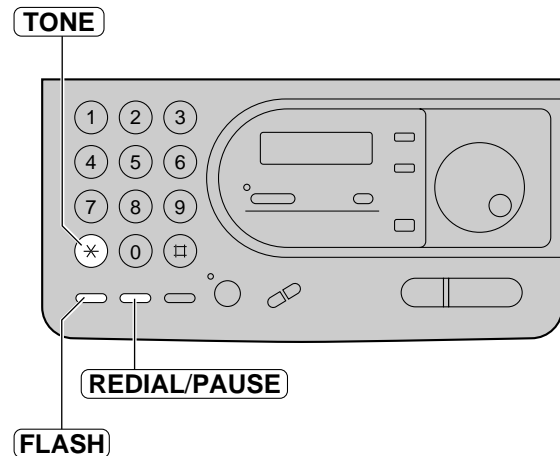

Telephone

Entering pauses

When the **REDIAL/PAUSE** button is pressed during dialing, a pause will be inserted.

Example 1:

When your unit is connected to a host exchange, insert a pause before the telephone number to get an outside line.

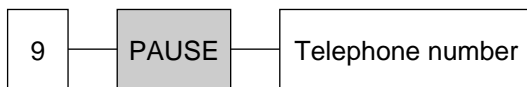

Line access code

Example 2:

If a transmission error occurs during an overseas transmission, add two pauses at the end of the telephone number.

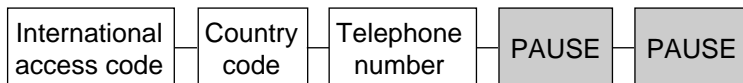

Note:

- TONE, FLASH and PAUSE can be stored into a telephone number in the EASY DIAL directory.

Storing names and telephone numbers in the EASY DIAL directory

You can store up to 100 names and telephone numbers for rapid access to frequently dialed numbers.

1 Press **DIRECTORY EDIT**.

The number of entries available in the directory

Display:

↓

2 Enter the name, up to 10 characters, by following the instructions on the next page.

Example:

3 Press **START/COPY/SET**.

4 Enter the telephone number up to 30 digits.

Example:

5 Press **START/COPY/SET**.

↓

• To program other items, repeat steps 2 to 5.

6 Press **STOP** to exit the program.

Note:

- To confirm the stored names and telephone numbers, print a telephone number list (see page 65).
- You can store items during a telephone conversation.
- After 95 items are stored, the following message will be displayed in step 5.

- By rotating **EASY DIAL** to the right, stored items can be displayed. The order is as follows: alphabet, number, symbol and telephone number (when a name is not stored).

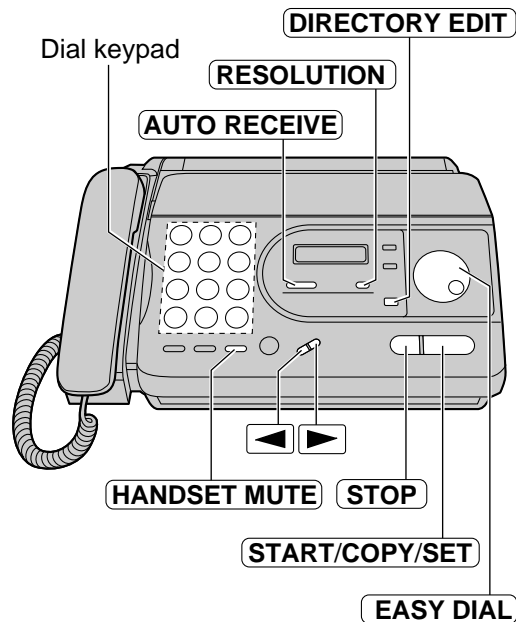

To correct a mistake

- Press **◀** or **▶** to move the cursor to the incorrect character, then make the correction.

To delete a character

- Move the cursor to the character you want to delete and press **STOP**.

To keep the telephone number secret

Press **RESOLUTION** after entering the telephone number in step 4.

- The telephone number will not appear on the telephone number list.
- Pressing **RESOLUTION** does not count as a digit.

Selecting characters with the dial keypad

Pressing the dial keys will select a character as shown below.

Keys	Characters
①	1 [] { } + - / = , . _ ' : ; ?
②	A B C a b c 2
③	D E F d e f 3
④	G H I g h i 4
⑤	J K L j k l 5
⑥	M N O m n o 6
⑦	P Q R S p q r s 7
⑧	T U V t u v 8
⑨	W X Y Z w x y z 9
⑩	0 () < > ! " # \$ % & ¥ * @ ^ ' □
AUTO RECEIVE	Insert key (Used to insert a space.)
HANDSET MUTE	Hyphen key (Used to insert a hyphen in the telephone number.)
RESOLUTION	Secret key (Used to keep the telephone number secret.)
VOLUME ▼	◀ key (Used to move the cursor to the left.)
VOLUME ▲	▶ key (Used to move the cursor to the right.) To enter the same number key continuously, move the cursor to the next space.

Note:

- A hyphen or a space entered in a telephone number is counted as two digits.

Selecting characters with the EASY DIAL

Instead of pressing the dial keys, you can select characters using the EASY DIAL.

1. Rotate **EASY DIAL** until the desired character is displayed.
2. Press ▶ to move the cursor to the next space.
 - The character displayed in step 1 is inserted.
3. Return to the step 1 to enter the next character.

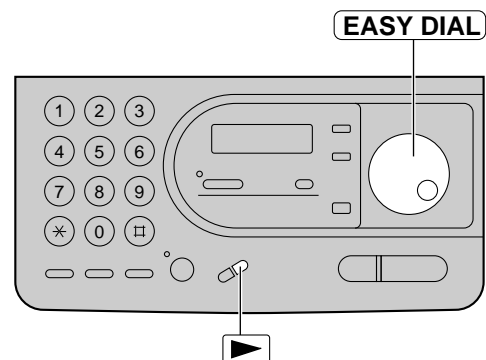

Display order of characters

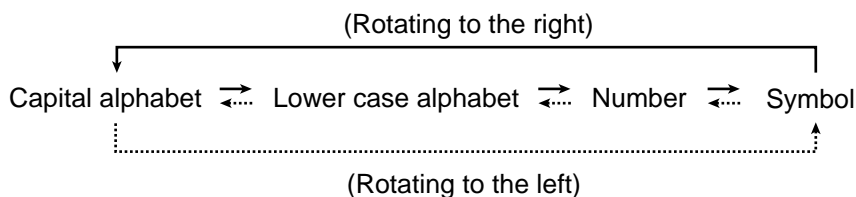

Editing a stored name and number

- 1 Rotate **EASY DIAL** until the desired name is displayed.
Example:
- 2 Press **DIRECTORY EDIT**.
- 3 Press ***** to select "EDIT".
- If you do not need to edit the name, skip to step 5.
- 4 Edit the name by following the instructions on page 27.
- 5 Press **START/COPY/SET**.
Example:
- If you do not need to edit the telephone number, skip to step 7.
- 6 Edit the telephone number. For further details, see page 26.
- 7 Press **START/COPY/SET**.

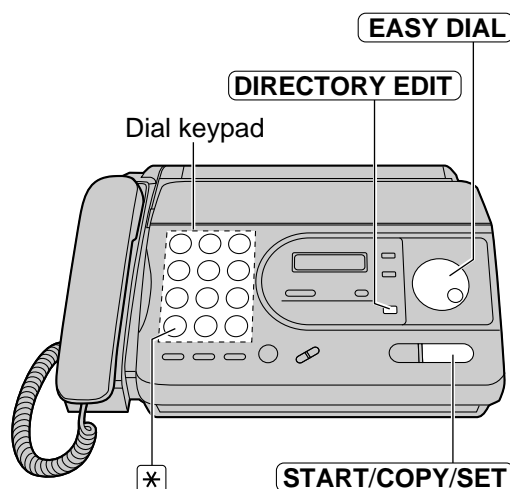

Erasing a stored name and number

- 1 Rotate **EASY DIAL** until the desired name is displayed.
Example:
- 2 Press **DIRECTORY EDIT**.
- 3 Press **#** to select "DELETE".

↕
- If you do not want to erase the item, press **STOP**.
- 4 Press **START/COPY/SET**.
- The stored name and number are deleted.

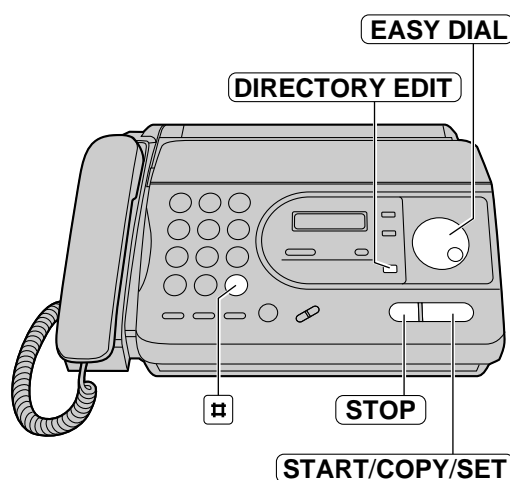

Making a voice call using the EASY DIAL directory

- 1** Rotate **EASY DIAL** until the desired name is displayed.

Example:

- 2** Press **MONITOR** or lift the handset.
- The unit will start dialing automatically.

- 3** When the other party answers, talk using the handset.

- 4** When finished, hang up the handset.

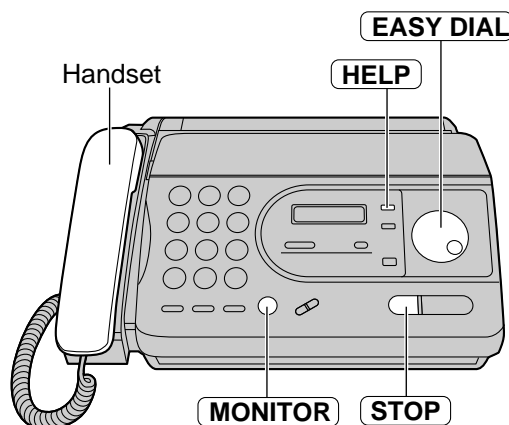

Telephone

Note:

- If the desired name has not been stored, press **STOP** and dial the number manually.
To store the name and number, see page 26.

Searching for a name by the initial

Example: When you want to search for the name "Lisa"

1. Rotate **EASY DIAL** until any name is displayed.

Example:

2. Press **5** repeatedly until any name with the initial "L" is displayed (see the character table on page 27).

3. Rotate **EASY DIAL** to the right until "Lisa" is displayed.

- To stop the operation, press **STOP**.
4. Press **MONITOR** or lift the handset, and the unit will automatically dial the number.

Note:

- When you want to search for symbols (not alphabet or numbers), press the ***** key in step 2.

Confirming a stored telephone number

1. Rotate **EASY DIAL** until the desired name is displayed.

Example:

2. Press **HELP**.

- To stop the operation, press **STOP**.
3. Press **MONITOR** or lift the handset, and the unit will automatically dial the number.

Talking to the caller after fax transmission or reception

You can have a conversation with the same call after a fax message is completed. This will save the added expense and time of making another call.

This feature only works when the other party's unit is equipped with a voice contact feature.

Initiating voice contact

- 1 Press **MONITOR** while transmitting or receiving documents.

Display: VOICE STANDBY

- Your unit will call the other party with a distinctive ring.
- When the other party answers, your unit will emit a distinctive ring.

- 2 Lift the handset to start talking.

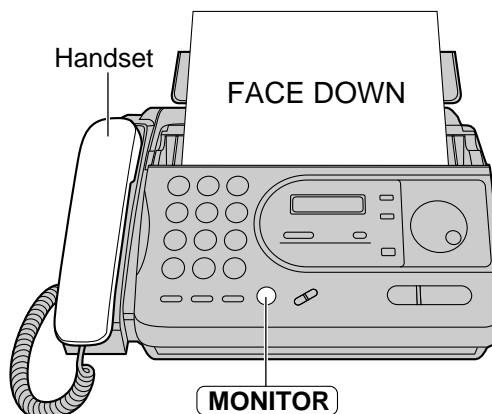

Note:

- If you initiate voice contact during transmission, you can talk after all of the documents have been transmitted.
- If you initiate voice contact during reception, you can talk after the current page of the document is received.

Receiving a request for voice contact

- 1 Your unit will sound a distinctive ring after transmission or reception is completed.

- 2 Lift the handset to start talking.

Note:

- If you do not answer within 10 seconds of the distinctive ring, the line will be automatically disconnected.

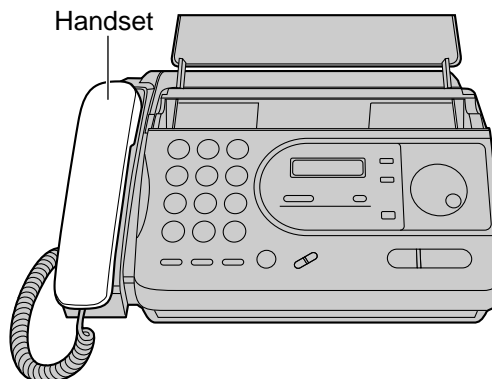

Sending faxes manually

- 1 Open the document feeder tray.
- 2 Adjust the width of the document guides to the size of the document.
- 3 Insert the document FACE DOWN (up to 5 sheets) until a beep tone is heard.

Display: STANDARD

- 4 Press **RESOLUTION** repeatedly to select the desired setting, if necessary (see the bottom of this page).

- 5 Press **MONITOR** or lift the handset.

TEL=

- 6 Dial the fax number.

Example: TEL=5678901

- 7 **When a fax tone is heard**, press **START/COPY/SET**, and hang up the handset if using it.

CONNECTING

Note:

- If the other party answers your call, ask them to start receiving a fax, then press your **START/COPY/SET**.

To feed 6 or more sheets at a time

Insert the first 5 sheets of the document. Add the extra sheets (up to 5) before the last sheet is fed into the unit.

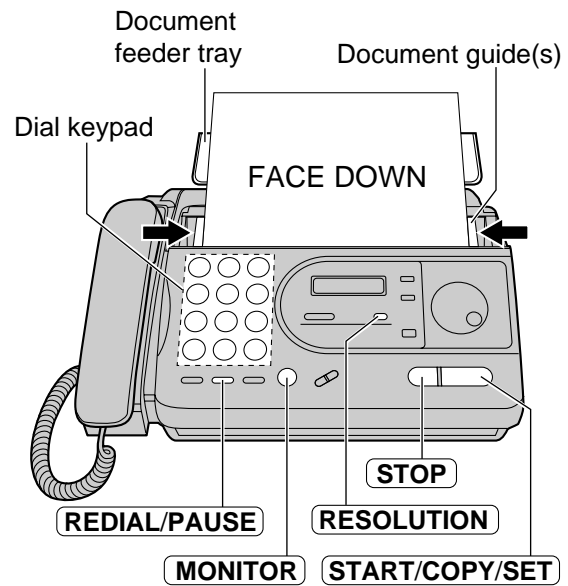

To redial the last number

Press **REDIAL/PAUSE**.

- If the line is busy, the unit will automatically redial the number up to 5 times.
- While waiting for redial, the following will be displayed.

WAITING REDIAL

To stop transmission

Press **STOP**.

To eject the document, press **STOP** again.

Selecting the resolution

Select the desired resolution according to the type of document.

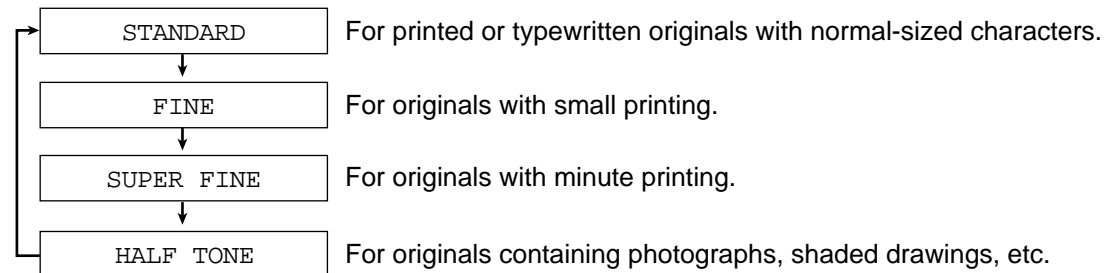

- Using the fine, super fine or half tone setting will increase the transmission time.
- If the resolution setting is changed during feeding, it will be effective from the next sheet.
- The super fine resolution only works with other compatible machines.

Sending faxes using the EASY DIAL directory

Before using this feature, program the desired names and telephone numbers into the directory (see page 26). To confirm the items stored in the directory, print a telephone number list (see page 65).

- 1 Open the document feeder tray.
- 2 Adjust the width of the document guides to the size of the document.
- 3 Insert the document FACE DOWN (up to 5 sheets) until a beep tone is heard.

Display: STANDARD

- 4 Press **RESOLUTION** repeatedly to select the desired setting, if necessary (see the bottom of page 31).

- 5 Rotate **EASY DIAL** until the desired name is displayed.

Example: Kim

- 6 Press **START/COPY/SET**.

Example: TEL=2223333



CONNECTING

- The unit will start transmission.

Note:

- If the desired name has not been stored, press **STOP** and dial the number manually. To store the name, see page 26.
- For further details about using the EASY DIAL, see page 29.

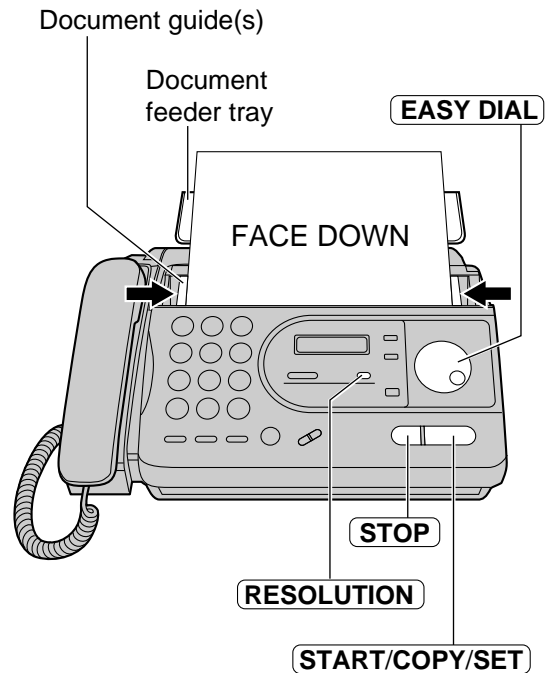

Fax auto redial

If the line is busy or there is no answer, the unit will automatically redial the number up to 5 times.

- This feature is also available for;
 - delayed transmission (page 36)
 - receive polling (page 52)
- While waiting for redial, the following will be displayed.

Display: WAITING REDIAL

- To cancel redialing, press **STOP**.

Documents you can send

Minimum size

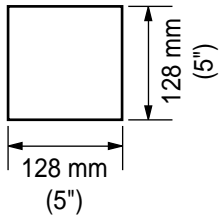

Maximum size

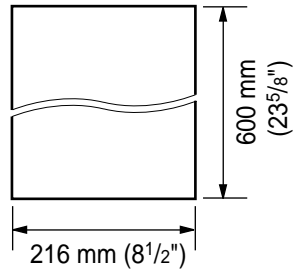

Effective scanning area

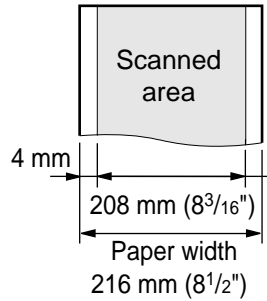

Document weight

Single sheet:
45 to 90 g/m² (12 to 24 lb.)

Multiple sheets:
60 to 75 g/m² (16 to 20 lb.)

Note:

- Remove clips, staples or other similar fastening objects.
- Check that ink, paste or correction fluid has dried.
- Do not send the following types of documents. Use copies for fax transmission.
 - Chemically treated paper such as carbon or carbonless duplicating paper
 - Electrostatically charged paper
 - Heavily curled, creased or torn paper
 - Paper with a coated surface
 - Paper with a faint image
 - Paper with printing on the opposite side that can be seen through the front (e.g. newspaper)

Printing the transmission report

The transmission report will provide you with a printed record of the fax transmission result. One of the following choices is available.

- ERROR:** The transmission report will print out only when fax transmission fails (pre-selected setting).
- ON:** The transmission report will always print out, indicating whether fax transmission is successful or not.
- OFF:** The transmission report will not print.

- 1** Press **MENU**.
 Display: 1.SYSTEM SET UP
- 2** Press **04**, then **04**.
 TX-REPORT MODE
- 3** Press **START/COPY/SET**.
 MODE=ERROR ▼▲
- 4** Press ▼ or ▲ to select the desired setting.
- 5** Press **START/COPY/SET**.
 SETUP ITEM []
- 6** Press **MENU**.

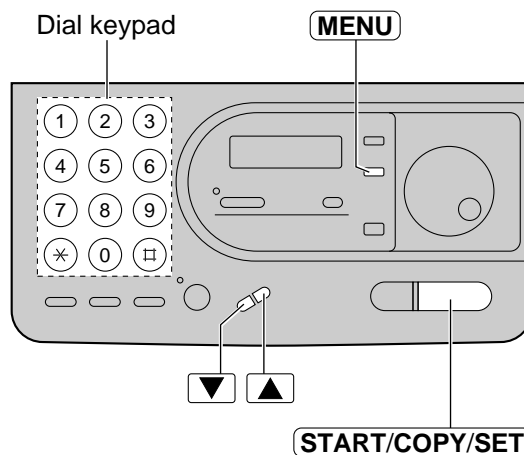

Sample of a transmission report

TRANSMISSION REPORT						
JAN. 20 1998 01:19PM						
NO.	OTHER FACSIMILE	START TIME	USAGE TIME	MODE	PAGES	RESULT
01	2345678	JAN. 20 01:18PM	00'51	SND	00	COMMUNICATION ERROR (65)

Communication message
(See page 57.)

Error code (for service personnel use only)

Setting the journal report to print automatically

The journal report will provide you with a printed record of the last 35 fax communication results. After printing, the oldest communication result will be erased when a new communication occurs. When this feature is deactivated, the unit will store the records of the fax communications, but will not print the journal report automatically.

- 1 Press **MENU**.
Display: 1.SYSTEM SET UP
- 2 Press **□**, then **2 2**.
AUTO JOURNAL
- 3 Press **START/COPY/SET**.
MODE=ON ▼▲
- 4 Press ▼ or ▲ to select the desired setting.
• If this feature is not required, select "OFF".
- 5 Press **START/COPY/SET**.
SETUP ITEM []
- 6 Press **MENU**.

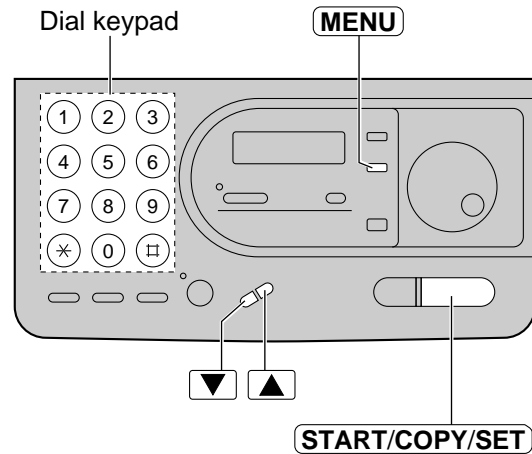

Fax/Copy

Sample of a journal report

JOURNAL							
JAN. 25 1998 05:22PM							
NO.	OTHER FACSIMILE	START TIME	USAGE TIME	MODE	PAGES	RESULT	*CODE
01	3332222	JAN. 21 02:14PM	00'45	SND	01	OK	
02	9998765	JAN. 21 03:17PM	00'58	SND	02	OK	
03	2121444	JAN. 21 05:18PM	00'48	RCV	01	OK	
04	555556677	JAN. 22 10:35AM	02'45	SND	03	COMMUNICATION ERROR	(65)
			03'50	SND	05	OK	
				RCV	03	OK	

Communication message
(See page 57.)

Error code (for service personnel use only)

Delayed transmission

(sending a fax at a specific time)

Using a built-in clock, this unit can send documents automatically at a specific time. This allows you to take advantage of low-cost calling hours offered by your telephone company. The delayed transmission can be reserved to take place up to 24 hours in advance.

1 Insert the document FACE DOWN.

Display: STANDARD

2 Press **MENU**.

1.SYSTEM SET UP

3 Press **#**, then **2** **5**.

DELAYED SEND

4 Press **START/COPY/SET**.

MODE=OFF ▼▲

5 Press ▼ or ▲ to select "ON".

MODE=ON ▼▲

• If this feature is not required, select "OFF".

6 Press **START/COPY/SET**.

NO. =

7 Enter the fax number.

8 Press **START/COPY/SET**.

TIME=12:00AM

9 Enter the transmission start time.
Example: 11:30PM
 Press **1** **1** **3** **0**, then press ***** to select PM (or AM).

TIME=11:30PM

10 Press **START/COPY/SET**.

SETUP ITEM []

11 Press **MENU**.

SEND AT 11:30PM

• When the programmed time has come, the unit will automatically start transmission.

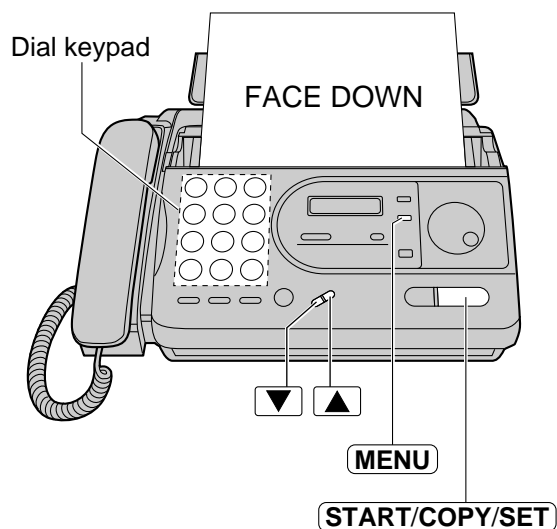

Note:

- You can receive, transmit and copy documents while delayed transmission is set.
- When transmit polling (see page 37) is set to "ON", delayed transmission is not available.
- You cannot use the EASY DIAL directory to enter the fax number for this feature.

Sending documents overseas

You may experience difficulty when transmitting documents overseas. This feature makes sending documents easier as the transmission speed is slowed down. Before starting transmission, follow the steps below.

- 1 Press **MENU**.
Display: 1.SYSTEM SET UP
- 2 Press **□**, then **2** **3**.
OVERSEAS MODE
- 3 Press **START/COPY/SET**.
MODE=OFF ▼▲
- 4 Press ▼ or ▲ to select "ON".
MODE=ON ▼▲
 - If this feature is not required, select "OFF".
- 5 Press **START/COPY/SET**.
SETUP ITEM []
- 6 Press **MENU**.

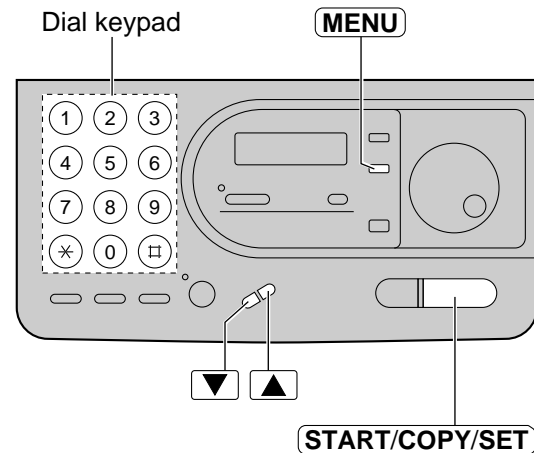

Note:

- After transmission, this feature will turn off automatically.

Transmit polling (letting another machine retrieve a fax on your unit)

This feature allows another person to call your unit to retrieve a document loaded on your unit. This saves you the call charges. This feature will not work when the unit is set to the TEL mode.

- 1 Insert the document FACE DOWN.
Display: STANDARD
- 2 Press **MENU** four times.
4.POLLED
↕
YES: PRESS SET
- 3 Press **START/COPY/SET**.
MODE=OFF ▼▲
- 4 Press ▼ or ▲ to select "ON".
MODE=ON ▼▲
 - If this feature is not required, select "OFF".
- 5 Press **START/COPY/SET**.
POLLED ON

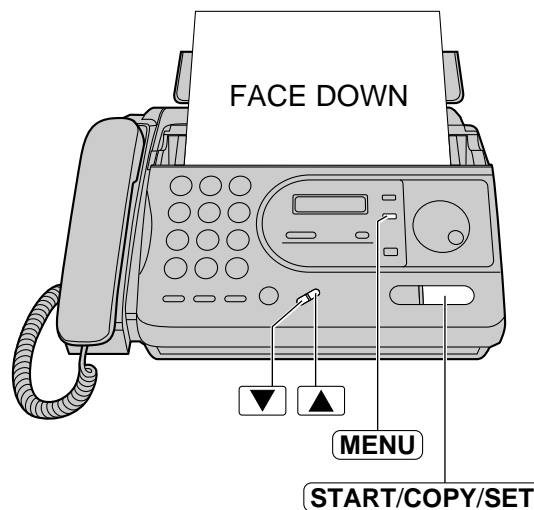

Note:

- The caller pays for the document transmission.
- When delayed transmission (see page 36) is set to "ON", transmit polling is not available.

Selecting the way to receive calls

This unit has four types of receive modes. Select one of these modes according to your needs.

- Regardless of the mode you select, you can always place calls and send faxes.

MANUAL RECEIVE

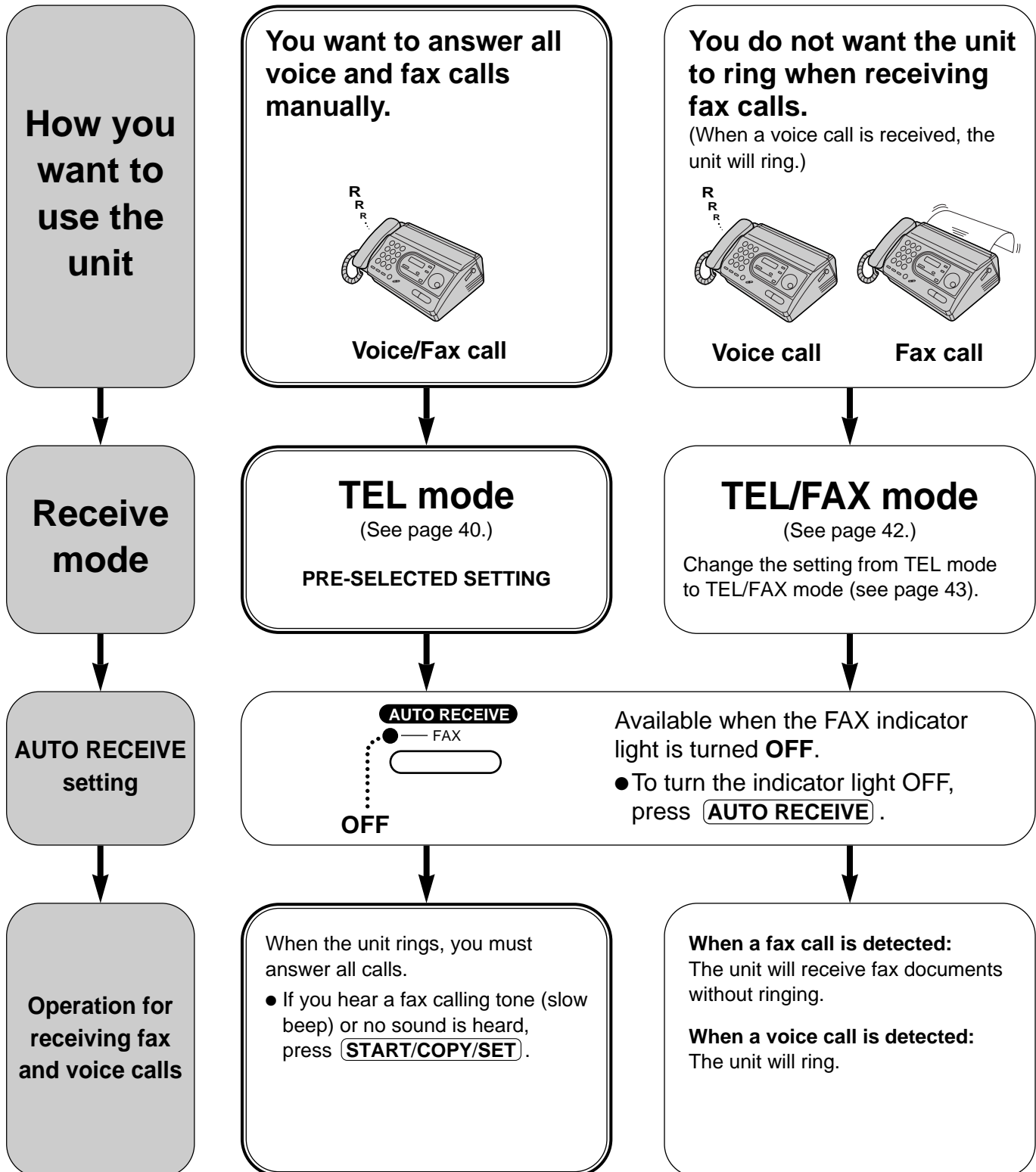

AUTO RECEIVE

Fax/Copy

You want to receive fax documents only.

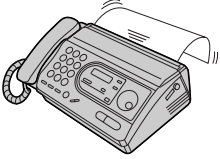

Fax call only

FAX ONLY mode
(See page 41.)
PRE-SELECTED SETTING

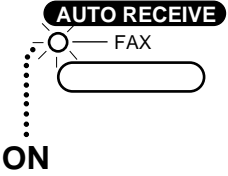

The unit will automatically answer all calls and only receive fax documents.

You want to record voice messages and receive fax documents.

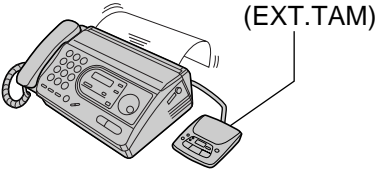

Voice/Fax call

EXT.TAM mode
(See page 45.)
Change the setting from FAX ONLY mode to EXT.TAM mode (see page 46).

Available when the FAX indicator light is turned **ON**.

- To turn the indicator light ON, press **AUTO RECEIVE**.

When receiving voice calls:
The external telephone answering machine will record voice messages.

When receiving fax calls:
The facsimile unit will receive documents.

TEL mode --- ---

(answering all calls manually)

1 When the unit rings, lift the handset to answer the call.

2 When:
—document reception is required,
—a fax calling tone (slow beep) is heard, or
—no sound is heard,
press **START/COPY/SET**.

Display: CONNECTING

3 Hang up the handset.
• The unit will start reception.

Note:

- If you do not answer the call by 15 rings, the unit will temporarily switch to the fax and the caller can send documents.
- If the MANUAL RECEIVE setting is set to the TEL/FAX mode, reset it to the TEL mode (see page 43).

To stop receiving

Press **STOP**.

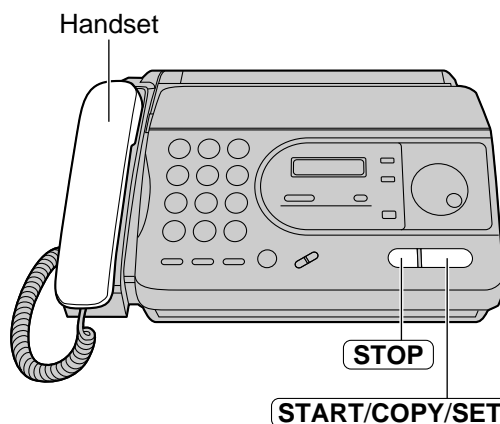

Friendly reception feature

When you answer a call and hear a fax calling tone (slow beep), the unit will automatically start receiving even if you do not press **START/COPY/SET**.

- If this feature is not required, set to "OFF" (see page 54).

FAX ONLY mode

(all calls are received as faxes)

Activating the FAX ONLY mode

Turn on the AUTO RECEIVE mode by pressing **AUTO RECEIVE** until the FAX indicator light turns on.

- The display will show the following.

Display: FAX ONLY MODE

- If the AUTO RECEIVE setting is set to the EXT.TAM mode, reset it to the FAX ONLY mode (see page 46).
- The unit will automatically answer all calls and only receive fax documents.
- The number of rings before a call is answered can be changed (see below).

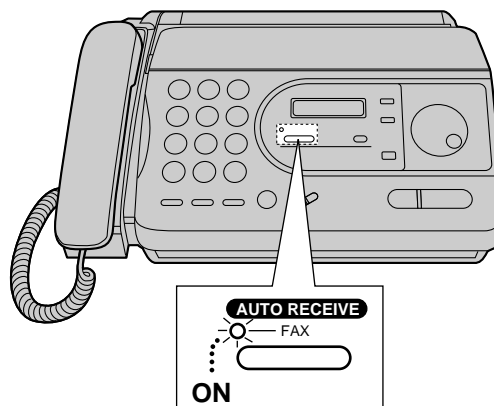

Setting the FAX ONLY mode ring count

This setting determines the number of rings before the unit answers a call in the FAX ONLY mode. You can choose from 1 to 4 rings.

Helpful hints:

- To answer a call before the unit does, increase the number of rings.
- If you have difficulty receiving faxes from machines that have an automatic transmission feature, decrease the number of rings.

- Press **MENU**.
Display: 1.SYSTEM SET UP
- Press **Ⓜ**, then **0 7**.
FAX RING
- Press **START/COPY/SET**.
RING=1 ▼▲
- Press ▼ or ▲ to select the desired number.
- Press **START/COPY/SET**.
SETUP ITEM []
- Press **MENU**.

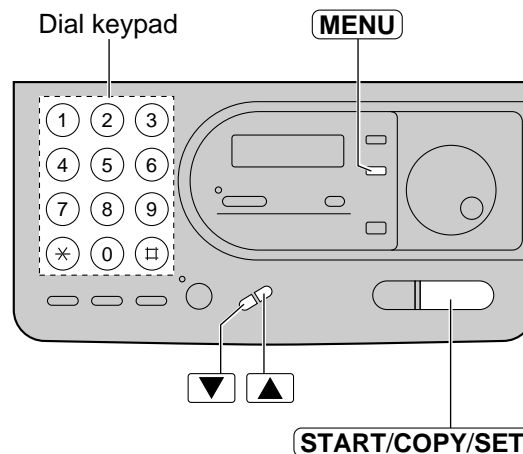

TEL/FAX mode ===== (receiving voice calls with rings and fax calls without rings)

Use this mode when you wish to receive voice calls with rings, but do not want the unit to ring when faxes are received.

When a call is received, the unit will work as follows.

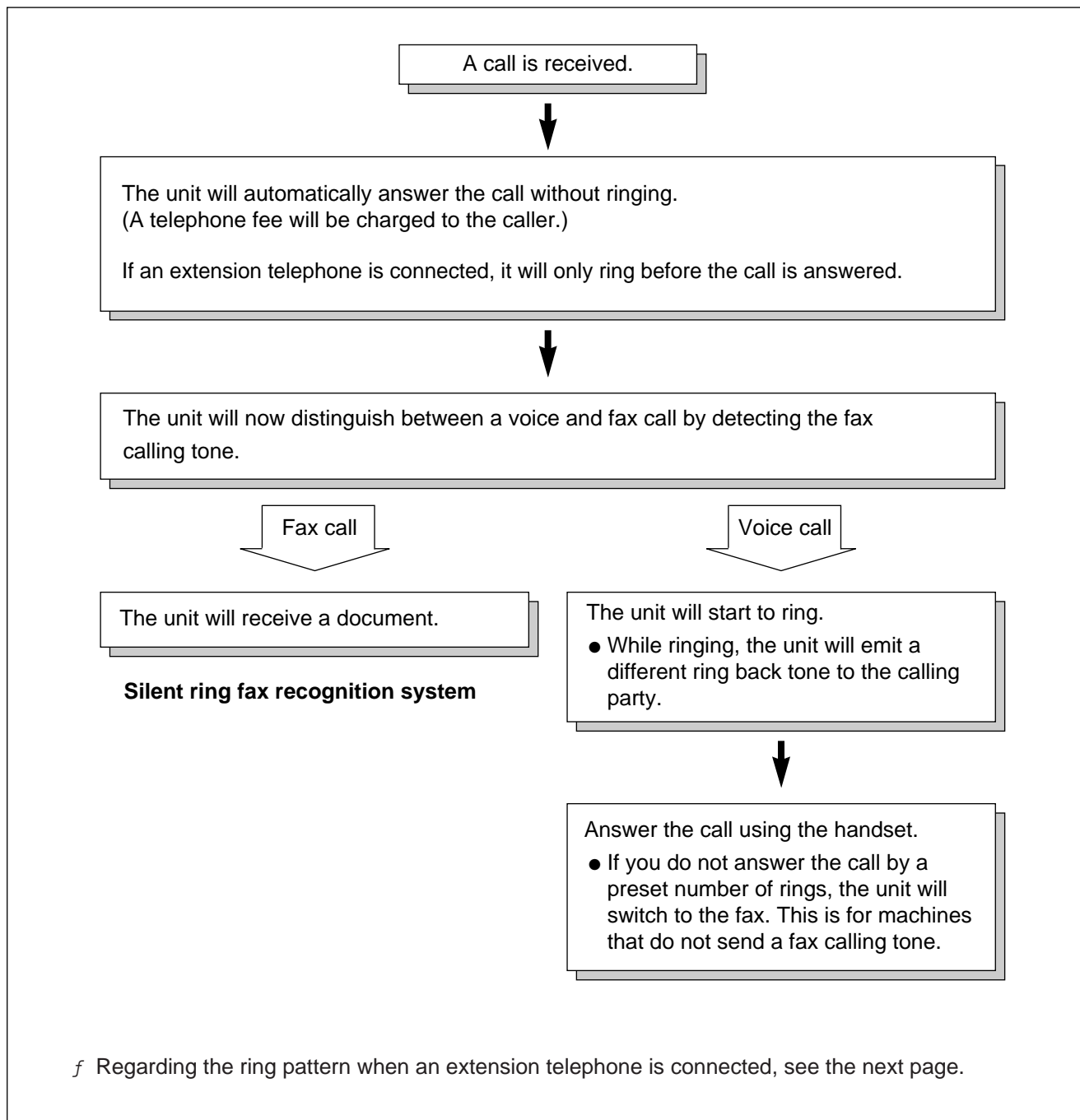

Note:

- Some fax messages that are transmitted manually may not send a fax calling tone. These calls must be received manually.

Ring pattern when an extension telephone is connected

When an extension telephone is connected to the unit, it will ring as follows.

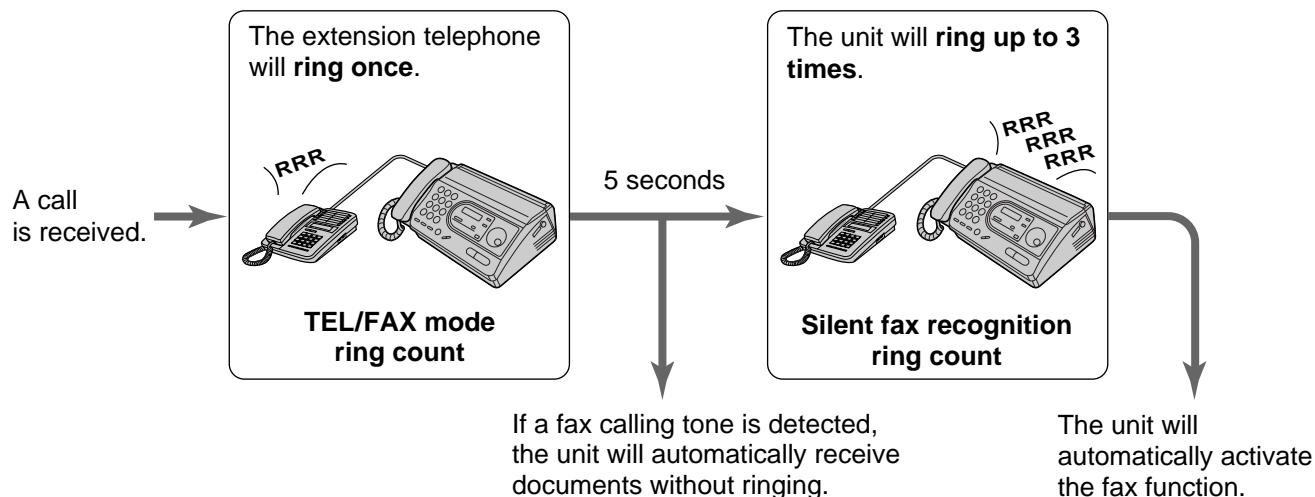

Note:

- You can change the **TEL/FAX mode ring count** and **silent fax recognition ring count** (see page 44).
- The unit will display the following when the extension telephone starts to ring.

INCOMING CALL

Fax/Copy

Changing the TEL mode to the TEL/FAX mode

Change the MANUAL RECEIVE setting from the TEL mode to the TEL/FAX mode.

- 1 Press **MENU**.
Display: 1.SYSTEM SET UP
- 2 Press **□**, then **0 8**.
MANUAL RECEIVE
- 3 Press **START/COPY/SET**.
MODE=TEL ▼▲
- 4 Press ▼ or ▲ to select "TEL/FAX".
MODE=TEL/FAX ▼▲
- 5 Press **START/COPY/SET**.
SETUP ITEM []
- 6 Press **MENU**.
- 7 If the FAX indicator light is on, turn it off by pressing **AUTO RECEIVE**.
TEL/FAX MODE

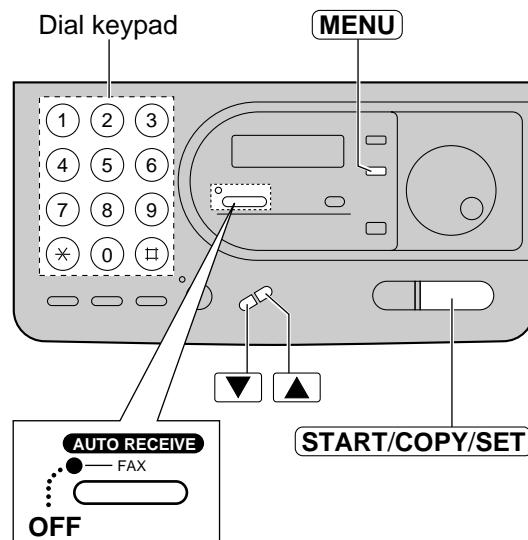

Note:

- To return to the TEL mode, select "TEL" in step 4.

Setting the TEL/FAX mode ring count

This setting determines the number of the extension telephone rings in the TEL/FAX mode. You can choose from 1 to 4 rings.

When an extension telephone is not connected, changing this setting is not necessary.

- 1 Press **MENU**.
Display: 1.SYSTEM SET UP
- 2 Press **Ⓜ**, then **0 9**.
TEL/FAX RING
- 3 Press **START/COPY/SET**.
RING=1 ▼▲
- 4 Press ▼ or ▲ to select the desired number.
- 5 Press **START/COPY/SET**.
SETUP ITEM []
- 6 Press **MENU**.

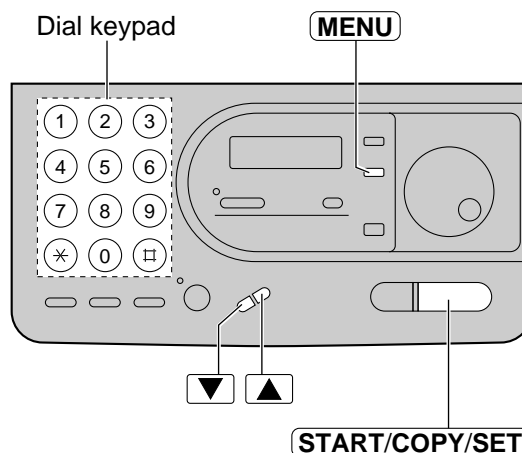

Note:

- If the number of rings is increased, you may not be able to receive documents from some older model facsimiles which do not send a fax calling tone.

Setting the silent fax recognition ring count

When the unit detects a voice call in the TEL/FAX mode, it will ring up to 3 times. The number of rings can be changed up to 9. If a voice call is not answered within the selected number of rings (3 to 9 rings), the unit will automatically start to receive a fax.

- 1 Press **MENU**.
Display: 1.SYSTEM SET UP
- 2 Press **Ⓜ**, then **3 0**.
SILENT FAX RING
- 3 Press **START/COPY/SET**.
RING=3 ▼▲
- 4 Press ▼ or ▲ to select the desired number.
- 5 Press **START/COPY/SET**.
SETUP ITEM []
- 6 Press **MENU**.

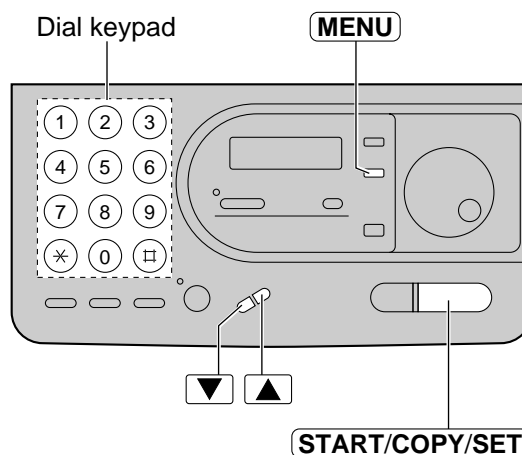

Note:

- If the number of rings is increased, you may not be able to receive documents from some older model facsimiles which do not send a fax calling tone.

EXT.TAM mode --- ---

(using with an external telephone answering machine)

You can connect an external telephone answering machine (EXT.TAM). When the EXT.TAM mode is set, the unit and answering machine will work as follows.

■Receiving voice calls

The external telephone answering machine will record voice messages automatically.

■Receiving fax calls

The unit will receive documents automatically.

■Receiving a voice message and fax document in one call

The external telephone answering machine will record the voice message first. Then, the unit will be activated by the caller's request and receive the document. For further details, see page 47.

Connecting an external telephone answering machine ---

- 1 Connect the answering machine to the EXT jack.

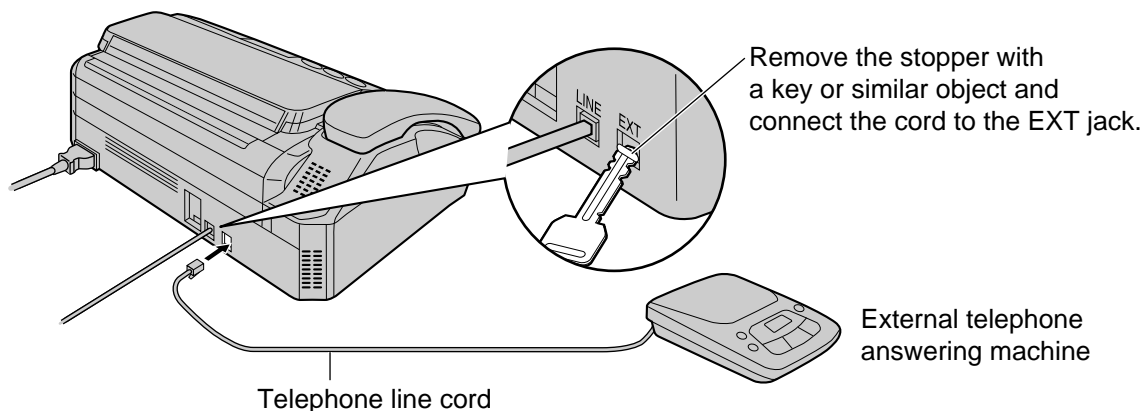

Fax/Copy

- 2 Set the number of rings on the answering machine to less than 4.
 - This will allow the answering machine to answer the call first.
- 3 Record a greeting message into the answering machine.

Example: *"This is (your name, business and/or telephone number). We are unable to answer the phone right now. Please leave a message after the long beep. To send a fax, start transmission. Thank you."*

Note:

- Do not pause for 4 or more seconds during the greeting message. If a 4 second pause is stored in the greeting message, all incoming calls will be routed to the unit from the answering machine even while the greeting message is playing.
- We recommend you keep the greeting message around 10 seconds long. If the greeting message is too long, some incoming fax calls may not be answered by the unit.
- If your answering machine is equipped with a remote operation feature, set the same remote access code that is on the answering machine to the unit (see page 47).

Changing the FAX ONLY mode to the EXT.TAM mode

Change the AUTO RECEIVE setting from the FAX ONLY mode to the EXT.TAM mode.

- 1 Press **MENU**.
Display: 1.SYSTEM SET UP
- 2 Press **☐**, then **0 5**.
AUTO RECEIVE
- 3 Press **START/COPY/SET**.
MODE=FAX ONLY▼▲
- 4 Press ▼ or ▲ to select "EXT.TAM".
MODE=EXT.TAM ▼▲
- 5 Press **START/COPY/SET**.
SETUP ITEM []
- 6 Press **MENU**.

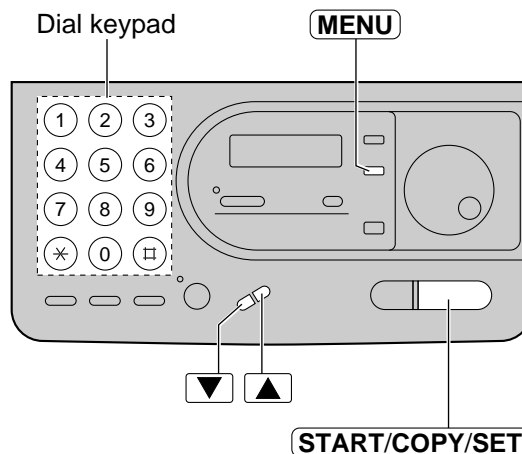

Note:

- To return to the FAX ONLY mode, select "FAX ONLY" in step 4.

Activating the EXT.TAM mode

- 1 Turn on the external answering machine.
- 2 Press **AUTO RECEIVE** on the unit until the FAX indicator light turns on.
Display: EXT.TAM MODE

Note:

- If the answering machine is not turned on, all incoming calls will be answered by the unit and callers cannot leave voice messages.
- Every time the unit receives a document, a silent pause or fax tone may be recorded on the answering machine.
- Set the TEL mode under the following conditions:
 - when you wish to set the number of rings on the answering machine to more than 5, or
 - when you wish to use the auto transfer functions (transfer, pager alert, etc.) on the answering machine.
- Automatic fax sending cannot be received automatically in the TEL mode.

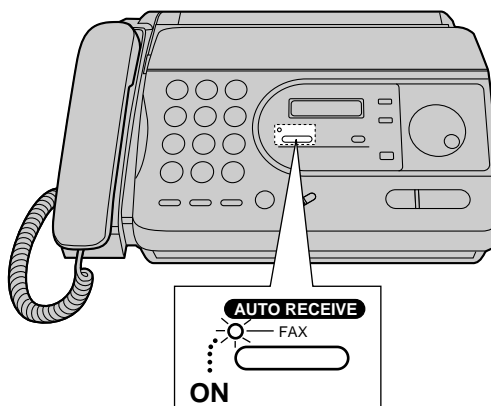

Securing the remote operation for the external telephone answering machine (remote activation ID)

Depending on your external telephone answering machine, you can retrieve recorded voice messages from a remote location. Set the remote activation ID code for the answering machine.

Important:

- This ID should be different from the fax activation code (see page 51).

1 Press **MENU**.
Display: 1.SYSTEM SET UP

2 Press **#**, then **1 2**.
REMOTE TAM ACT.

3 Press **START/COPY/SET**.
MODE=OFF ▼▲

4 Press ▼ or ▲ to select "ON".
MODE=ON ▼▲

5 Press **START/COPY/SET**.
ID=11

- The display will show the pre-selected ID.

6 Enter your ID number.
• This ID can be from 1 to 5 digits in length using 0 - 9, * and #.

7 Press **START/COPY/SET**.
SETUP ITEM []

8 Press **MENU**.

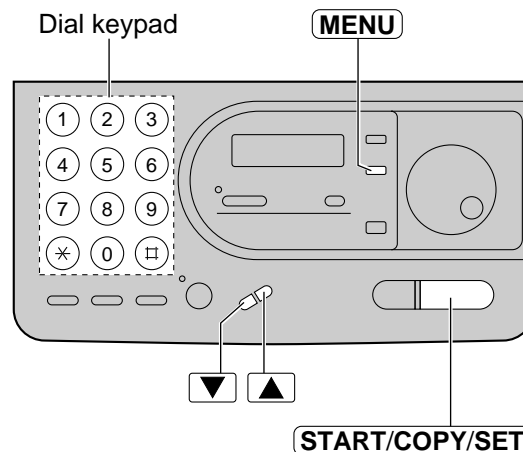

Receiving a voice message and fax document in one call

The caller can leave a voice message and send a fax document during the same call. Inform the caller of the following procedures beforehand.

1. The caller calls your unit.
 - The external telephone answering machine will answer the call.
2. The caller can leave their message after the greeting message.
3. The caller presses *** 9** (pre-selected fax activation code).
 - The unit will activate the fax function.
4. The caller presses their start button to send a document.

Note:

- The fax activation code can be changed (see page 51).
- If the wrong fax activation code is entered, the caller must wait more than 5 seconds to reenter the correct code.





Distinctive ring service --- --- (ring pattern detection feature)

This feature can only be used when you subscribe to a distinctive ring service from your telephone company. For more information on the availability of this service, contact your telephone company before activating this feature.

What is a distinctive ring service? ---

A distinctive ring service will give you up to 3 telephone numbers on a single telephone line, each having a different ringing pattern.

Ring patterns:

Standard ring (one long ring)	
Double ring (two short rings)	
Triple ring (short-long-short rings)	
Other triple ring (short-short-long rings)	

When you subscribe to a distinctive ring service, you can assign telephone numbers for personal telephone numbers, business telephone numbers, fax telephone numbers, and so on. When a call is received, you will know which number is being called by the ringing pattern.

Example:

Your telephone number	Ring pattern	Use
012 1234	Standard ring	Personal
012 5678	Double ring	Business
012 9876	Triple ring	Facsimile

To use one of the telephone numbers as a facsimile number ---

Program the ring pattern assigned to the facsimile number. When the unit detects a call matching the selected distinctive ring pattern, it will activate depending on the receive mode setting (see the next page).

Setting the distinctive ring pattern assigned for faxes

Select the ring pattern of the facsimile number that is assigned by your telephone company.

- 1 Press **MENU**.
Display: 1.SYSTEM SET UP
- 2 Press **Ⓜ**, then **3 1**.
RING DETECTION
- 3 Press **START/COPY/SET**.
MODE=OFF ▼▲
- 4 Press ▼ or ▲ to select the ring pattern assigned to the facsimile number.
 A: Standard ring (one long ring)
 B: Double ring (two short rings)
 C: Triple ring (short-long-short rings)
 D: Other triple ring (short-short-long rings)
 OFF: Turns off the feature (pre-selected setting).
- 5 Press **START/COPY/SET**.
PRINTING
 • The unit will print an information list.
 SETUP ITEM []
- 6 Press **MENU**.

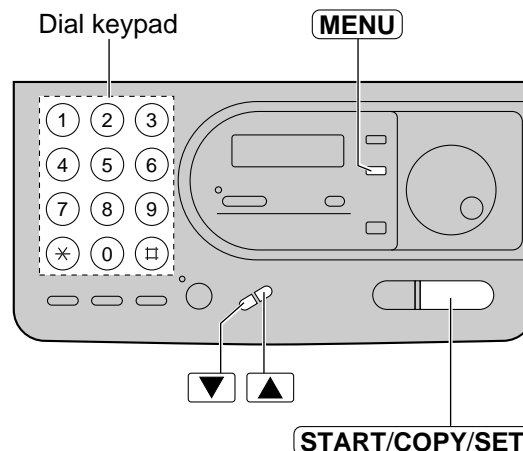

How the unit will answer in each receive mode

- TEL mode:** You have to answer all calls manually.
If a fax calling tone (slow beep) is heard or no sound is heard, press **START/COPY/SET** to receive documents.
- TEL/FAX mode:** When a call that matches your selected ring pattern is detected, the unit will automatically answer the call without ringing and activate the fax function.
When another ring pattern is received, the unit will ring until you answer the call.
- FAX ONLY mode:** The unit will answer all calls automatically and activate the fax function.
- EXT.TAM mode:** When a call that matches your selected ring pattern is detected, the unit will automatically answer the call and activate the fax function.
When another ring pattern is received;
—if it is a voice call, the external telephone answering machine will record the voice message.
—if it is a fax call, the unit will receive documents.

Note:

- In the FAX ONLY and EXT.TAM modes, the unit automatically answers a distinctive ring call after the second ring. To change the number of rings, change the FAX ONLY mode ring count (page 41) after setting the ring pattern.

Receiving faxes using an extension telephone =====

When you connect an extension telephone to your unit or on the same line, you can receive fax documents using the extension telephone.

You do not have to go to the unit and press **START/COPY/SET**.

Important:

- Use a touch tone telephone as the extension telephone and enter the fax activation code **firmly**.

1 When the extension telephone rings, lift the handset of the extension telephone.

2 When:
— document reception is required,
— a fax calling tone (slow beep) is heard, or
— no sound is heard,
press *** 9** (pre-selected fax activation code) **firmly**.

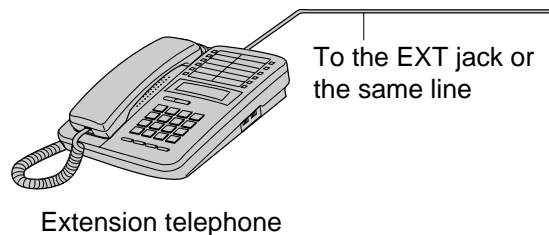

3 Hang up the handset.
● The unit will start reception.

Note:

- You can change the fax activation code (see the next page).

When an extension telephone is connected to the EXT jack:

- When the extension telephone is in use, the unit will show the following.

Display: EXT. IN USE

- When the extension telephone is in use and you press the **MONITOR** button or lift the handset of the unit, the call is switched to the unit, and the extension telephone will be disconnected.
- If no sound is heard when you lift the handset of the extension telephone, the unit is in use.

Changing the fax activation code

The fax activation code is used in the following cases;

- when receiving faxes using an extension telephone (see page 50).
- when receiving a voice message and fax document in one call (see page 47).

Important:

- This code should be different from the remote activation ID (see page 47).

- 1 Press **MENU**.
Display: 1.SYSTEM SET UP
- 2 Press **☐**, then **4 1**.
FAX ACTIVATION
- 3 Press **START/COPY/SET**.
MODE=ON ▼▲
- 4 Press ▼ or ▲ to select the desired setting.
• If this feature is not required, select "OFF".
- 5 Press **START/COPY/SET**.
CODE= * 9
• The display will show the pre-selected code.
- 6 Enter the new code number.
• This code can be from 2 to 4 digits in length using 0 - 9 and *.
- 7 Press **START/COPY/SET**.
SETUP ITEM []
- 8 Press **MENU**.

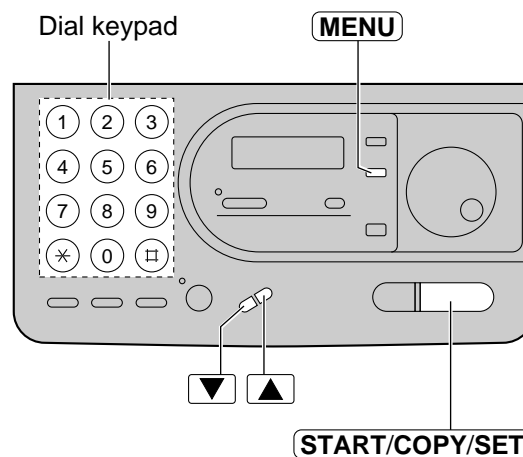

Note:

- If you subscribe to some special telephone company services, all or part of the fax activation code must be different from the service access code.
- The fax activation code should not be set to "0000".

Receive polling --- ---

(retrieving faxes placed on another party's machine)

This feature allows you to retrieve a document from another compatible machine. Therefore, you pay for the call, saving the sending party the call charges.

Make sure that no documents are fed into your unit and that the other party's machine is ready for your call.

- 1** Press **MENU** three times.
Display:
↕
- 2** Press **START/COPY/SET**.
- 3** Dial the fax number.
Example:
- 4** Press **START/COPY/SET**.

- The unit will start reception.

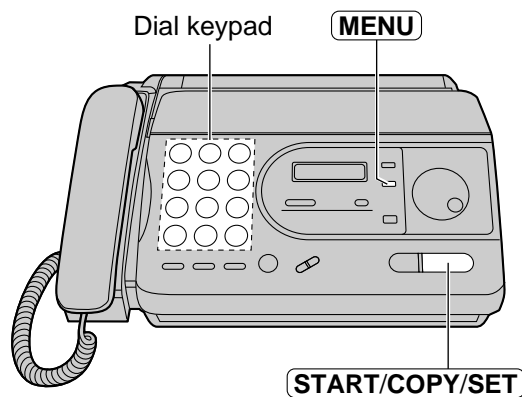

Note:

- You cannot use the EASY DIAL directory to enter the fax number for this feature.

Setting the silent detection

(receiving faxes from older model facsimiles)

This feature allows the unit to activate the fax function automatically when a silent pause longer than 4 seconds is detected in the EXT.TAM mode.

Helpful hints:

- If you wish to receive documents from machines that do not send a fax calling tone, activate this feature.
- If you use an external telephone answering machine to give greeting messages and record incoming messages on a single cassette tape, deactivate this feature.

- 1 Press **MENU**.
Display: 1.SYSTEM SET UP
- 2 Press **⏏**, then **4 0**.
SILENT DETECT.
- 3 Press **START/COPY/SET**.
MODE=ON ▼▲
- 4 Press ▼ or ▲ to select the desired setting.
• If this feature is not required, select "OFF".
- 5 Press **START/COPY/SET**.
SETUP ITEM []
- 6 Press **MENU**.

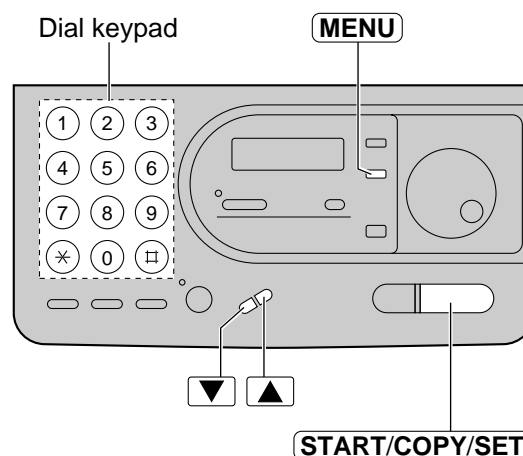

Setting the friendly reception

The friendly reception feature allows you to receive fax documents automatically without pressing **START/COPY/SET** (see page 40).

When this feature is deactivated, you will have to press **START/COPY/SET** to receive fax documents each time you answer a fax call.

- 1** Press **MENU**.
Display: 1.SYSTEM SET UP
- 2** Press **#**, then **4** **6**.
FRIENDLY RCV
- 3** Press **START/COPY/SET**.
MODE=ON ▼▲
- 4** Press ▼ or ▲ to select the desired setting.
● If this feature is not required, select "OFF".
- 5** Press **START/COPY/SET**.
SETUP ITEM []
- 6** Press **MENU**.

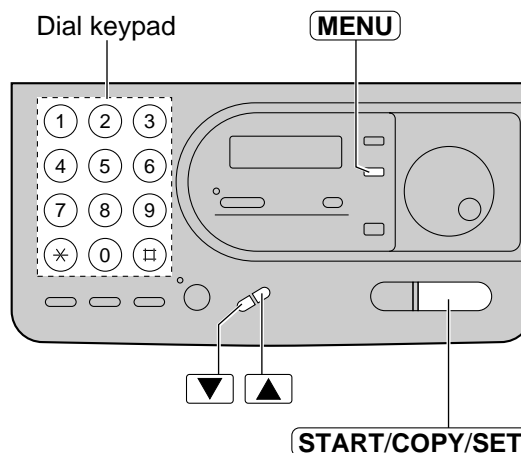

Signaling your pager when your unit receives a fax

This feature allows your unit to call your pager when your unit receives a fax document.

1 Press **MENU**.
Display: 1.SYSTEM SET UP

2 Press **□**, then **7 0**.
FAX PAGER

3 Press **START/COPY/SET**.
MODE=OFF ▼▲

4 Press ▼ or ▲ to select "ON".
MODE=ON ▼▲

- If this feature is not required, select "OFF".

5 Press **START/COPY/SET**.
NO. =

6 Enter your pager number.
• You can enter a total of 46 digits and/or pauses.

Example: NO. =1122333

7 Press **START/COPY/SET**.
SETUP ITEM []

8 Press **MENU**.

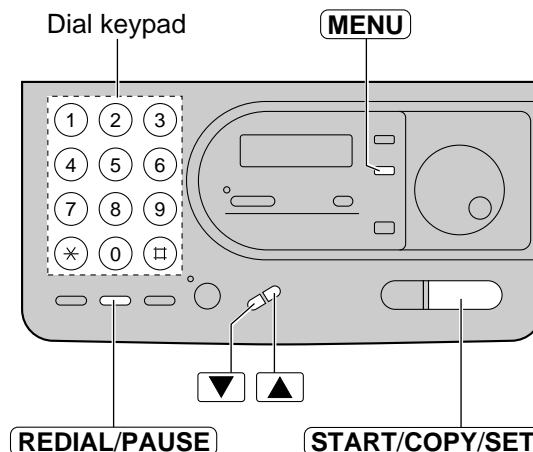

Note:

- If this feature does not work properly, enter more than one pause by pressing **REDIAL/PAUSE** at the end of your pager number to extend the paging time.
- If you wish to display a message on your pager, enter your pager number, pause(s) and the message.
- Message programming methods may vary depending on the pager company. Contact your pager company for details.

Making a copy

Any transmittable document (see page 33) can be copied.

- 1 Open the document feeder tray.
- 2 Adjust the width of the document guides to the size of the document.
- 3 Insert the document (up to 5 sheets) **FACE DOWN** until a beep tone is heard.

Display:

- 4 Press **RESOLUTION** repeatedly to select the desired setting, if necessary (see the bottom of page 31).

- 5 Press **START/COPY/SET**.
 - The unit will start printing.

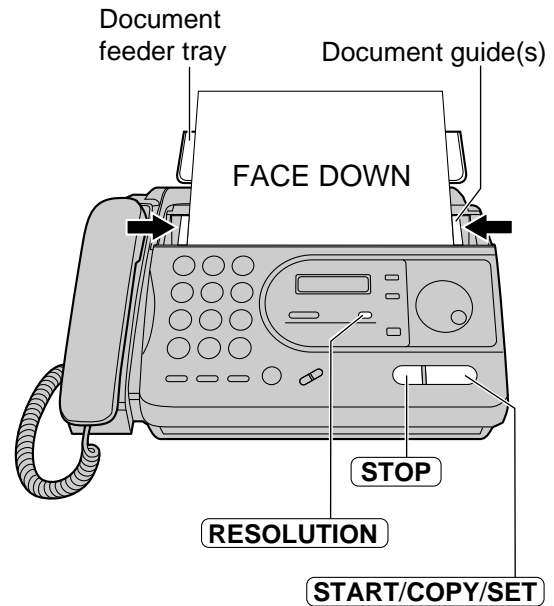

Note:

- When you copy a multiple page document which is longer than A4 size paper (approx. 300 mm), we recommend to insert the pages one at a time.
- If a resolution is not set, FINE resolution will automatically be selected.
- You can make or receive a voice call while making a copy.

To stop copying

Press **STOP**.

To eject the document, press **STOP** again.

Error messages on printed reports

When a problem has occurred, one of the following messages will be printed on the transmission and journal reports (see pages 34 and 35).

Communication message	Error code	Cause & Remedy
COMMUNICATION ERROR	41–72 FF	<ul style="list-style-type: none"> ● A transmission or reception error occurred. Try again or check with the other party.
DOCUMENT JAMMED	—	<ul style="list-style-type: none"> ● The document is jammed. Remove the jammed document (p. 63).
ERROR-NOT YOUR UNIT	53, 54 59, 70	<ul style="list-style-type: none"> ● A transmission or reception error occurred because of a problem with the other party's machine. Check with the other party.
NO DOCUMENT	—	<ul style="list-style-type: none"> ● The document was not fed into the unit properly. Reinsert the document and try again.
OTHER FAX NOT RESPOND	—	<ul style="list-style-type: none"> ● The other party's machine was busy or ran out of recording paper. Try again. ● The document was not fed properly. Reinsert the document and try again. ● The other party's machine rings too many times. To send a fax manually, dial the number, confirm the fax tone, and press START/COPY/SET. ● The other party's machine is not a facsimile. Check with the other party.
PAPER OUT	—	<ul style="list-style-type: none"> ● The unit ran out of recording paper. Install a recording paper roll (p. 17).
PRESSED THE STOP KEY	—	<ul style="list-style-type: none"> ● The STOP button was pressed and fax communication was canceled.
PRINTER OVERHEATED	—	<ul style="list-style-type: none"> ● The printer overheated. Let the unit cool down.
THE COVER WAS OPENED	—	<ul style="list-style-type: none"> ● The cover was opened. Close it and try again.
OK	—	<ul style="list-style-type: none"> ● Fax communication was successful.

Error messages on the LCD display --- ---

If the unit detects a problem, one or more of the following messages will appear on the display.

Display message	Cause & Remedy
CALL SERVICE	<ul style="list-style-type: none"> ● There is something wrong with the unit. Contact your service personnel.
CHECK COVER	<ul style="list-style-type: none"> ● The cover is open. Close it.
CHECK DOCUMENT	<ul style="list-style-type: none"> ● The document is not fed into the unit properly. Reinsert the document and try again. If misfeeding occurs frequently, clean the document feeder rollers (p. 64). If the problem remains, adjust the feeder pressure (p. 63). ● Attempted to transmit a document longer than 600 mm (23⁵/₈"). Press the STOP button to remove the document. Divide the document into two or more sheets and try again.
CHECK MEMORY	<ul style="list-style-type: none"> ● Memory (telephone numbers, parameters, etc.) has been erased. Re-program.
NO RESPONSE	<ul style="list-style-type: none"> ● The other party's machine is busy or ran out of recording paper. Try again.
OUT OF PAPER	<ul style="list-style-type: none"> ● The unit ran out of recording paper. Install a recording paper roll (p. 17).
POLLING ERROR	<ul style="list-style-type: none"> ● The other party's machine does not have a polling feature. Check with the other party.
REDIAL TIME OUT	<ul style="list-style-type: none"> ● The other party's machine is busy or ran out of recording paper. Try again.
REMOVE DOCUMENT	<ul style="list-style-type: none"> ● The document is jammed. Remove the jammed document (p. 63).
TRANSMIT ERROR	<ul style="list-style-type: none"> ● A transmission error occurred. Try again.
UNIT OVERHEATED	<ul style="list-style-type: none"> ● The unit is too hot. Let the unit cool down.

When a function does not work, check here before requesting help

General

Problem	Cause & Remedy
I cannot make and receive calls.	<ul style="list-style-type: none"> ● The power cord or telephone line cord is not connected. Check the connections (p. 18).
I cannot make calls.	<ul style="list-style-type: none"> ● The dialing mode setting is wrong. Change to TONE or PULSE (p. 18).
The unit does not work.	<ul style="list-style-type: none"> ● Disconnect the unit from the telephone line and connect the line to a known working telephone. If the working telephone operates properly, contact your service personnel to have the unit repaired. If the working telephone does not operate properly, contact your telephone company.
The unit does not ring.	<ul style="list-style-type: none"> ● The ringer volume is set to off. Adjust to a suitable level (p. 23).
The REDIAL/PAUSE button does not function properly.	<ul style="list-style-type: none"> ● If this button is pressed during dialing, a pause will be inserted. If pressed immediately after a dial tone is obtained, the last number dialed will be redialed.
The receive mode does not function as explained on pages 38 and 39.	<ul style="list-style-type: none"> ● A distinctive ringing pattern is set (p. 48).
During programming, I cannot enter the code or the ID number.	<ul style="list-style-type: none"> ● All or part of their numbers are the same. Change the number (p. 47, 51).

Fax transmission

Problem	Cause & Remedy
I cannot send documents.	<ul style="list-style-type: none"> ● The telephone line cord is connected to the EXT jack on the unit. Connect to the LINE jack (p. 18).
The other party complains that letters on their received document are distorted.	<ul style="list-style-type: none"> ● If your line has special telephone services such as call waiting, the service may have been activated during fax transmission. Connect the unit to a line that does not have these services. ● The extension telephone on the same line is off the hook. Hang up the extension telephone and try again.
The other party complains that dirty patterns or black lines appear on their received documents.	<ul style="list-style-type: none"> ● The glass or rollers are dirty. Clean them (p. 64).
I cannot make an international fax call.	<ul style="list-style-type: none"> ● Use the overseas transmission mode (p. 37). ● Add two pauses at the end of the telephone number (p. 25).

Fax reception

Problem	Cause & Remedy
I cannot receive documents.	<ul style="list-style-type: none"> ● The telephone line cord is connected to the EXT jack on the unit. Connect to the LINE jack (p. 18).
I cannot receive documents automatically.	<ul style="list-style-type: none"> ● The receive mode is set to the TEL mode. Set to the TEL/FAX, FAX ONLY or EXT.TAM mode. ● The time to answer the call is too long. Decrease the number of rings (p. 41, 44).
The recording image is faint.	<ul style="list-style-type: none"> ● The sender transmitted a faint document. Ask them to transmit a clearer copy of the document. ● The thermal head is dirty. Clean it (p. 64).
The received document is blank.	<ul style="list-style-type: none"> ● The recording paper roll is installed incorrectly. Make sure that the shiny side of the paper is facing down and re-install the paper (p. 17).

Copying

Problem	Cause & Remedy
A dirty pattern or a black line appears on the copied documents.	<ul style="list-style-type: none"> ● The glass or rollers are dirty. Clean them (p. 64).
The copied image is distorted.	<ul style="list-style-type: none"> ● The thermal head is dirty. Clean it (p. 64).
The copied document is blank.	<ul style="list-style-type: none"> ● The recording paper roll is installed incorrectly. Make sure that the shiny side of the paper is facing down and re-install the paper (p. 17).

Using an external telephone answering machine in the EXT.TAM mode

Problem	Cause & Remedy
I cannot receive documents automatically.	<ul style="list-style-type: none"> ● Your greeting message on the answering machine is too long. Shorten the message (up to 10 seconds). ● The answering machine rings too many times. Set to 1 or 2 rings. ● The silent detection feature is deactivated. Activate this feature (p. 53).
I cannot receive voice messages.	<ul style="list-style-type: none"> ● Check that the answering machine is turned on and connected to the unit properly (p. 45). ● Set the number of rings on the answering machine to 1 or 2.
I cannot retrieve recorded voice messages on the answering machine from a remote location.	<ul style="list-style-type: none"> ● The remote access code on your answering machine is the same as your fax activation code. Set a different number for each code. ● You did not program your remote access code in your facsimile correctly. Program the same code that is programmed on the answering machine (p. 47).
The greeting message on your answering machine is interrupted halfway and the caller cannot leave a voice message.	<ul style="list-style-type: none"> ● The greeting message has a silent pause longer than 4 seconds. Re-record the greeting message.
I pressed the remote access code to access the answering machine remotely, but the line was disconnected.	<ul style="list-style-type: none"> ● The code may include “#” which is used for certain features provided by the telephone company. Change the code on the answering machine to another number which does not include “#” (p. 47).
Callers complain that their voice message is interrupted halfway and they cannot leave a message.	<ul style="list-style-type: none"> ● Advise the caller not to pause for over 4 seconds while recording their voice message.
Callers complain that they cannot send a document.	<ul style="list-style-type: none"> ● Your answering machine ran out of recording tape. Rewind the tape to record messages. ● You set the answering machine to only give a greeting message.
When I answer a call with the extension telephone, the facsimile switches to the fax mode and I cannot talk with the other party.	<ul style="list-style-type: none"> ● You paused for over 4 seconds during the conversation. To resume the conversation, press the STOP button on the unit.

If a power failure occurs

- The unit will not function.
- The memory contents will not be erased.
- When you set delayed transmission and the programmed start time has passed during a power failure, the transmission will be attempted after power is restored.

Clearing a recording paper jam

If the unit does not eject any recording paper during reception or copying, the recording paper has jammed. Remove the jammed paper as shown below.

- 1 Open the cover by pressing the cover open button and remove the recording paper roll.

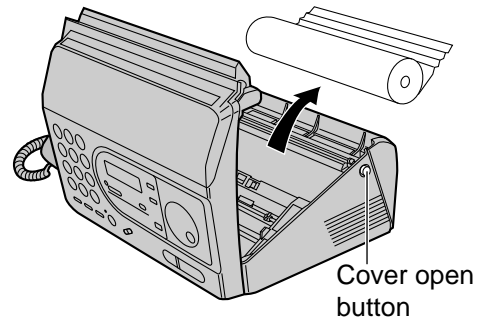

- 2 Replace the recording paper roll in the proper direction, and pull the leading edge of the paper approximately 10 cm (4 inches) out of the unit.
 - Make sure that there is no slack in the paper roll.

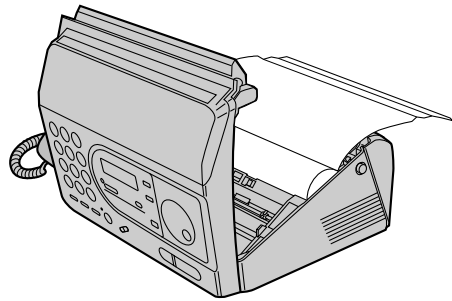

- 3 Close the cover securely by pushing down on both corners.
 - When you close the cover, do not push the flaps down or a paper jam will occur.

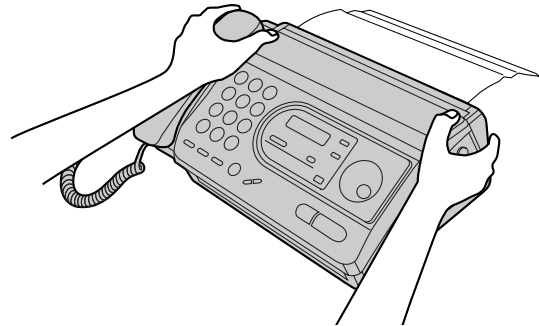
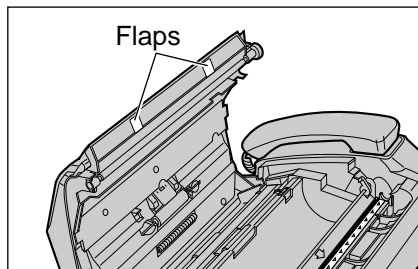

- 4 Tear off the excess paper by pulling it towards you.

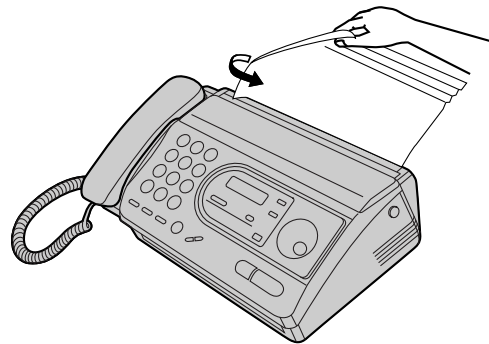

Note:

- When the power cord is connected, everytime you close the cover a message will be printed. If the recording paper is set to the wrong side, a message will not be printed. Install the paper correctly.

When a document you are sending jams

If the unit does not release the document during feeding, remove the document as follows.

- 1 Open the cover by pressing the cover open button.
- 2 Remove the jammed document carefully.
- 3 Close the cover securely by pushing down on both corners.

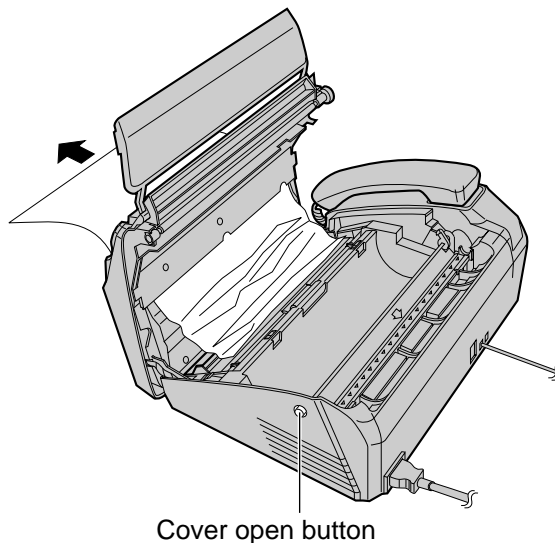

Note:

- Before opening the cover, do not pull out the jammed paper forcibly.

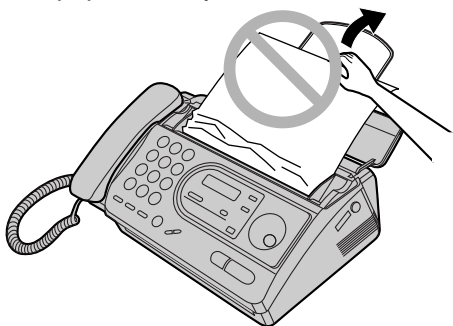

When documents you send do not feed, or multi-feed

If no feeding or multiple feeding occurs frequently, adjust the feeder pressure.

- 1 Open the cover by pressing the cover open button.
- 2 Shift the position of the lever by using an instrument with a pointed end, like a paper clip.
 - Right:** When documents do not feed.
 - Center:** Standard position (pre-selected)
 - Left:** When documents multiple feed.

- 3 Close the cover securely by pushing down on both corners.

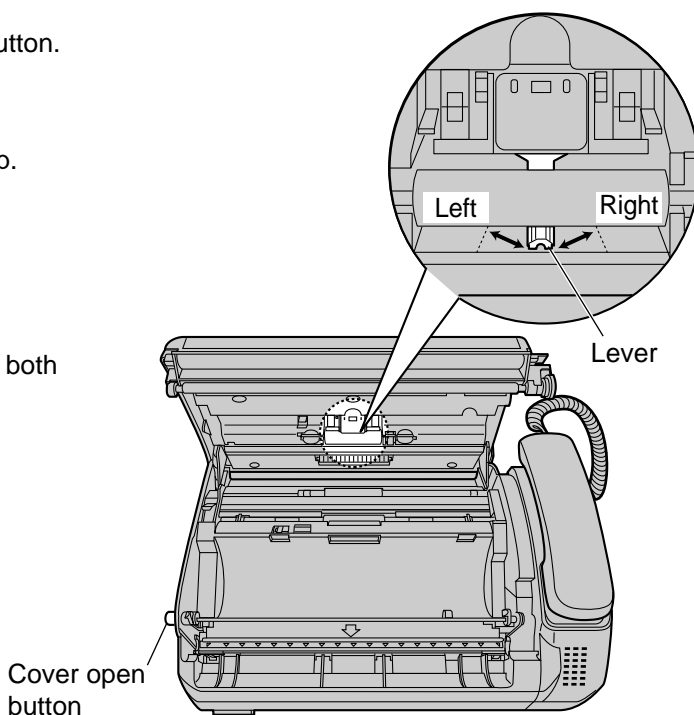

Help

Cleaning the document feeder

If misfeeding occurs frequently or if dirty patterns or black bands appear on a copied or transmitted document, clean the document feeder.

- 1** Disconnect the power cord and the telephone line cord.
- 2** Open the cover by pressing the cover open button.
- 3** Clean the document feeder rollers, sub roller and rubber flap with a cloth moistened with isopropyl rubbing alcohol, and let all parts dry thoroughly.
- 4** Clean the white plate and glass with a soft dry cloth.
- 5** Close the cover securely by pushing down on both corners.
- 6** Connect the power cord and the telephone line cord.

Caution:

- Do not use paper products, such as paper towels or tissues, to clean the inside of the unit.

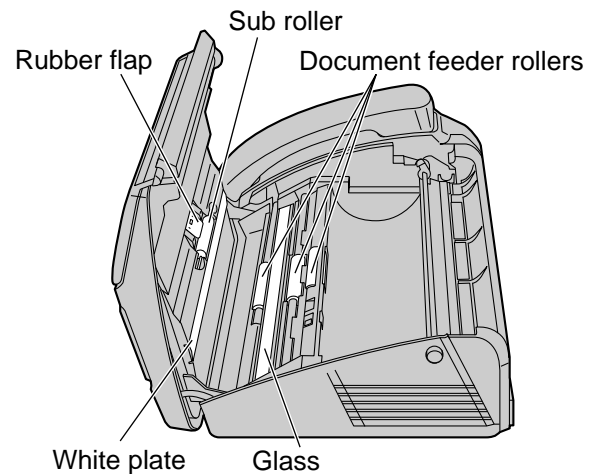
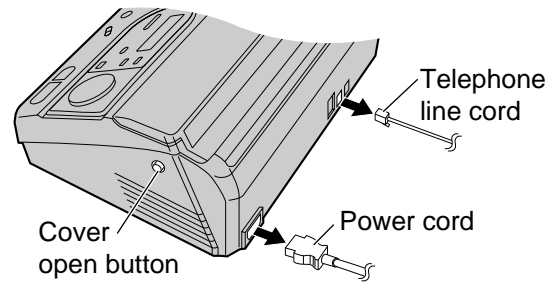

Cleaning the thermal head

If dirty patterns or black bands appear on a copied or received document, clean the thermal head.

- 1** Disconnect the power cord and the telephone line cord.
- 2** Open the cover by pressing the cover open button.
- 3** Clean the thermal head with a cloth moistened with isopropyl rubbing alcohol, and let it dry thoroughly.
- 4** Close the cover securely by pushing down on both corners.
- 5** Connect the power cord and the telephone line cord.

Caution:

- To prevent a malfunction due to static electricity, do not use a dry cloth and do not touch the thermal head directly with your fingers.

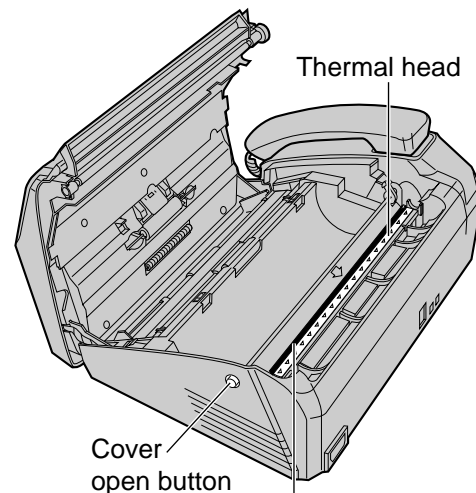

Caution:

- Do not push on the black cover.

Printing the feature settings, telephone numbers, and the journal

You can print out the following documents.

Basic feature list — provides you with the current settings of the basic programming features (see page 68).

Advanced feature list — provides you with the current settings of the advanced programming features (see page 69).

Telephone number list — provides you with names and telephone numbers which are stored in the EASY DIAL directory. The telephone number codes are as shown below.
 P: A pause has been entered.
 F: A flash has been entered.
 []: A secret telephone number has been entered. (The telephone number is not printed.)

Journal report — keeps records of fax transmissions and receptions. Also, this report will be printed automatically after every 35 fax communications (see page 35).

1 Press **MENU** two times.
 Display: 2.PRINT LIST

2 For the **basic feature list**, press **[]**, then **1**.
BASIC LIST

For the **advanced feature list**, press **[]**, then **2**.
ADVANCED LIST

For the **telephone number list**, press **[]**, then **3**.
TEL NO. LIST

For the **journal report**, press **[]**, then **4**.
JOURNAL REPORT

3 Press **START/COPY/SET** to start printing.
PRINTING

- To stop printing, press **STOP**.
- After printing, the following will be displayed.

PRINT ITEM []

4 Press **MENU**.

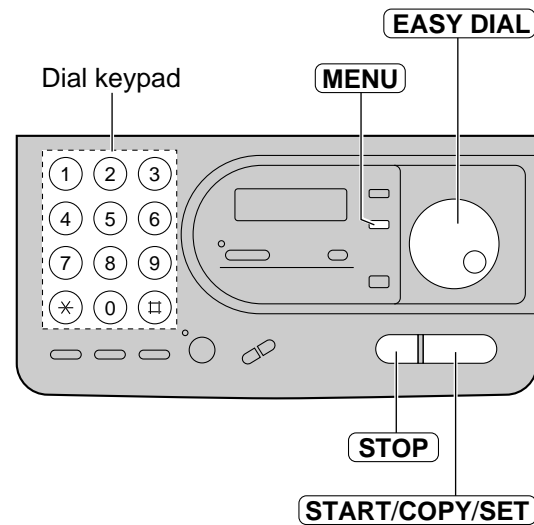

Note:

- In step 2, you can select the feature by rotating **EASY DIAL**.

Changing the LCD display contrast

Use this feature to adjust the display contrast.

NORMAL: (Pre-selected setting)

LIGHT: Used when the display contrast is too dark.

DARKER: Used when the display contrast is too light.

- 1** Press **MENU**.
Display: 1.SYSTEM SET UP
- 2** Press **□**, then **3** **9**.
LCD CONTRAST
- 3** Press **START/COPY/SET**.
MODE=NORMAL ▼▲
- 4** Press ▼ or ▲ to select the desired setting.
- 5** Press **START/COPY/SET**.
SETUP ITEM []
- 6** Press **MENU**.

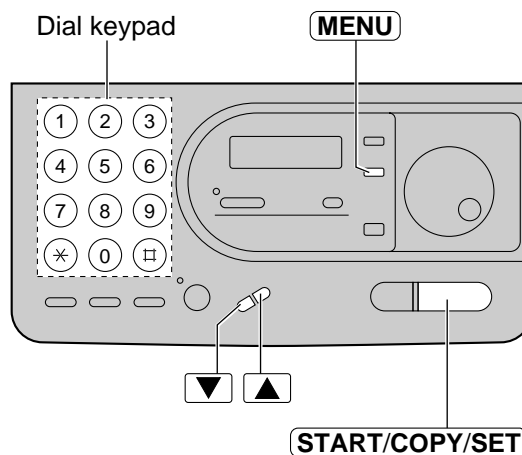

Resetting the advanced features

Use this feature to return the advanced features (see page 69) to their pre-selected settings.

- 1 Press **MENU**.
Display: 1.SYSTEM SET UP
- 2 Press **▣**, then **8 0**.
SET DEFAULT
- 3 Press **START/COPY/SET**.
RESET=NO ▼▲
- 4 Press ▼ or ▲ to select "YES".
RESET=YES ▼▲
- 5 Press **START/COPY/SET**.
RESET OK?
- If this feature is not required, press **STOP**.
- 6 Press **START/COPY/SET** again for confirmation.
RESET COMPLETED
↓
SETUP ITEM []
- 7 Press **MENU**.

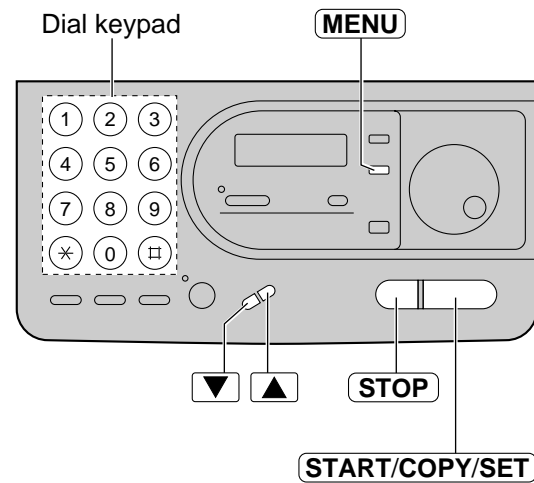

Summary of user programmable features

Basic features

Code	Feature & Display	Available settings	Meaning	Page
#01	Setting the date and time <div style="border: 1px solid black; padding: 2px; display: inline-block;">SET DATE & TIME</div>	(2 digits for each entry)	mm/dd/yy hh:mm	19
#02	Setting your logo <div style="border: 1px solid black; padding: 2px; display: inline-block;">YOUR LOGO</div>	(Up to 30 characters)	/	20
#03	Setting your facsimile telephone number <div style="border: 1px solid black; padding: 2px; display: inline-block;">YOUR TEL NO.</div>	(Up to 20 digits)		22
#04	Printing the transmission report <div style="border: 1px solid black; padding: 2px; display: inline-block;">TX-REPORT MODE</div>	ERROR ON OFF	If transmission fails Activate Deactivate	34
#05	Changing the AUTO RECEIVE setting <div style="border: 1px solid black; padding: 2px; display: inline-block;">AUTO RECEIVE</div>	FAX ONLY EXT.TAM	Facsimile only mode External telephone answering machine mode	46
#07	Setting the FAX ONLY mode ring count <div style="border: 1px solid black; padding: 2px; display: inline-block;">FAX RING</div>	1, 2, 3, 4	1 to 4 rings	41
#08	Changing the MANUAL RECEIVE setting <div style="border: 1px solid black; padding: 2px; display: inline-block;">MANUAL RECEIVE</div>	TEL TEL/FAX	Telephone mode Telephone/Facsimile mode	43
#09	Setting the TEL/FAX mode ring count <div style="border: 1px solid black; padding: 2px; display: inline-block;">TEL/FAX RING</div>	1, 2, 3, 4	1 to 4 rings	44
#12	Securing the remote operation for the external telephone answering machine <div style="border: 1px solid black; padding: 2px; display: inline-block;">REMOTE TAM ACT.</div>	ON / ID=11 OFF	Activate Deactivate	47

(Pre-selected is in bold.)

Note:

- You can display the basic features in the order above by rotating **EASY DIAL** instead of entering the code number (#01, #02, etc.).

Advanced features

Code	Feature & Display	Available settings	Meaning	Page
#22	Setting the journal report to print automatically <input type="text" value="AUTO JOURNAL"/>	ON	Activate	35
		OFF	Deactivate	
#23	Sending documents overseas <input type="text" value="OVERSEAS MODE"/>	ON	Activate	37
		OFF	Deactivate	
#25	Sending a fax at a specific time <input type="text" value="DELAYED SEND"/>	ON	Activate	36
		OFF	Deactivate	
#30	Setting the silent fax recognition ring count <input type="text" value="SILENT FAX RING"/>	3, 4, 5, 6, 7, 8, 9	3 to 9 rings	44
#31	Setting the distinctive ring pattern <input type="text" value="RING DETECTION"/>	A, B, C, D	A to D patterns	49
		OFF	Deactivate	
#39	Changing the LCD display contrast <input type="text" value="LCD CONTRAST"/>	NORMAL	Normal contrast	66
		LIGHT	Lighter contrast	
		DARKER	Darker contrast	
#40	Setting the silent detection <input type="text" value="SILENT DETECT."/>	ON	Activate	53
		OFF	Deactivate	
#41	Changing the fax activation code <input type="text" value="FAX ACTIVATION"/>	ON / CODE= * 9	Activate	51
		OFF	Deactivate	
#46	Setting the friendly reception <input type="text" value="FRIENDLY RCV"/>	ON	Activate	54
		OFF	Deactivate	
#70	Signaling your pager when your unit receives a fax <input type="text" value="FAX PAGER"/>	ON	Activate	55
		OFF	Deactivate	
#80	Resetting the advanced features <input type="text" value="SET DEFAULT"/>	YES	Reset	67
		NO	Will not reset	

(Pre-selected is in bold.)

Technical data about this product

Applicable Lines:	Public Switched Telephone Network
Document Size:	Max. 216 mm (8½") in width Max. 600 mm (23 ⁵ / ₈ ") in length
Effective Scanning Width:	208 mm (8 ³ / ₁₆ ")
Printing Paper Size:	216 mm x max. 30 m (8½" x 98') roll
Effective Printing Width:	208 mm (8 ³ / ₁₆ ")
Transmission Time *:	Approx. 15 s/page (Original mode) Approx. 30 s/page (G3 Normal mode)
Scanning Density:	Horizontal: 8 pels/mm (203 pels/inch) Vertical: 3.85 lines/mm (98 lines/inch) —STANDARD mode 7.7 lines/mm (196 lines/inch) —FINE/HALF TONE mode 15.4 lines/mm (392 lines/inch) —SUPER FINE mode
Halftone Level:	64-level
Scanner Type:	Contact Image Sensor (CIS)
Printer Type:	Thermal Printing
Data Compression System:	Modified Huffman (MH), Modified READ (MR)
Modem Speed:	9,600 / 7,200 / 4,800 / 2,400 bps; Automatic Fallback
Operating Environment:	5–35 °C (41–95 °F), 45–85 % RH (Relative Humidity)
Dimensions (H xW xD):	135 x323 x229 mm (5 ⁵ / ₁₆ " x12 ²³ / ₃₂ " x9")
Mass (Weight):	Approx. 2.9 kg (6.4 lb.)
Power Consumption:	Standby: Approx. 6.5 W Transmission: Approx. 17 W Reception: Approx. 40 W Copy: Approx. 40 W Maximum: Approx. 125 W
Power Supply:	220-240 V AC, 50/60 Hz

* Transmission speed depends upon the contents of the pages, resolution, telephone line conditions and capability of the receiving unit.
The 15 second speed is based upon CCITT No.1 Test Chart.

CCITT No.1 Test Chart



Note:

- Any details given in these instructions are subject to change without notice.
- The pictures and illustrations in these instructions may vary slightly from the actual product.

Index

- A** Accessories 4
 Advanced feature list 65
 Advanced features 69
 (Resetting) 67
 AUTO RECEIVE button 38, 39
 AUTO RECEIVE mode 39
- B** Basic feature list 65
 Basic features 68
- C** Character table 21, 27
 Cleaning 64
 Connections 18
 COPY button 56
- D** Date and time 19
 Delayed transmission 36
 Dialing mode 18
 Directory feature 26, 29, 32
 Display contrast 66
 Distinctive ring service 48, 49
 Document size 33, 70
- E** EASY DIAL (Making a voice call) 29
 (Selecting characters) 21, 27
 (Sending faxes) 32
 (Storing) 26
 Error messages 57, 58
 EXT.TAM mode 39, 45
 Extension telephone 43, 50
 External telephone answering machine 45
- F** Facsimile telephone number 22
 Fax activation code 51
 Fax auto redial 32
 FAX ONLY mode 39, 41
 FAX ONLY ring count 41
 Fax pager 55
 Features summary 68, 69
 Feeder pressure 63
 FLASH button 25
 Friendly reception 40, 54
- H** HANDSET MUTE button 24
 HELP button 5
 Hyphen key 27
- I** Insert key 21, 27
- J** Jam 62, 63
 Journal auto print 35
 Journal report 65
- L** Location panel 14, 15
 Logo 20
- M** MANUAL RECEIVE mode 38
 MONITOR button 29, 30, 31
 Muting 24
- O** Overseas transmission mode 37
 Overview 16
- P** Paper jam 62, 63
 PAUSE button 25
 Polling (Receiving) 52
 (Transmitting) 37
 Power failure 61
 Power supply 18, 70
 Printing paper size 70
 Printing reports 65
 Programmable features 68, 69
- R** Recording paper 5, 17, 62
 REDIAL button 24, 31
 Remote activation ID 47
 RESOLUTION button 31
 Ring pattern detection 48, 49
- S** Secret key 27
 Set default 67
 Silent detection 53
 Silent fax recognition ring 44
 Specifications 70
- T** TEL mode 38, 40
 TEL/FAX mode 38, 42
 TEL/FAX ring count 44
 Telephone number list 65
 TONE button 25
 Transmission report 34
 Transmittable document 33
- V** Voice contact 30
 VOLUME button 23

Kyushu Matsushita Electric Co., Ltd.

1-62, 4-chome, Minoshima, Hakata-ku, Fukuoka 812-8531, Japan

Printed in Japan

PFQX1185ZA KS1297AN1018